



**SmartGen**  
ideas for power

# ACC4100

## DIESEL AIR COMPRESSOR CONTROLLER

### USER MANUAL

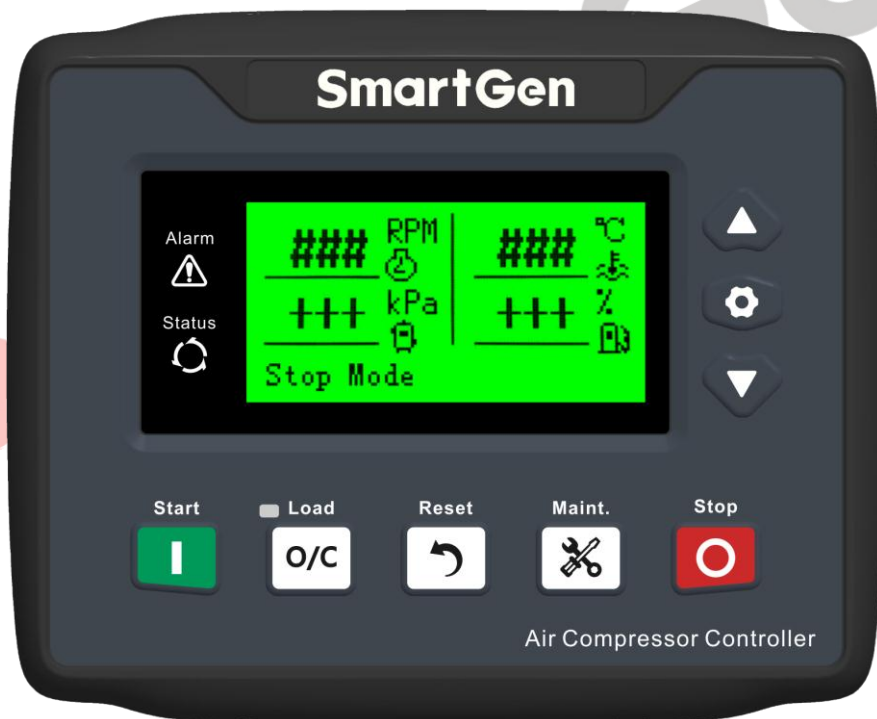

**SMARTGEN (ZHENGZHOU) TECHNOLOGY CO., LTD.**



Chinese trademark

**SmartGen** English trademark

SmartGen – make your generator *smart*

SmartGen Technology Co., Ltd.

No.28 Jinsuo Road,

Zhengzhou City

Henan Province

P.R. China

Tel: +86-371-67988888/67981888/67992951

+86-371-67981000 (overseas)

Fax: +86-371-67992952

Web: [www.smartgen.com.cn](http://www.smartgen.com.cn)

[www.smartgen.cn](http://www.smartgen.cn)

Email: [sales@smartgen.cn](mailto:sales@smartgen.cn)

All rights reserved. No part of this publication may be reproduced in any material form (including photocopying or storing in any medium by electronic means or other) without the written permission of the copyright holder.

Applications for the copyright holder’s written permission to reproduce any part of this publication should be addressed to SmartGen Technology at the address above.



Any reference to trademarked product names used within this publication is owned by their respective companies.

SmartGen Technology reserves the right to change the contents of this document without prior notice.

**Table 1 Software Version**

Date	Version	Note
2019-06-10	1.0	Original release.
2021-02-05	1.1	1. Add the new function description of the slave machine; 2. Modify “CAN H” sign of typical application.

**Table 2 Notation Clarification**

Sign	Instruction
 NOTE	Highlights an essential element of a procedure to ensure correctness.
 CAUTION!	Indicates a procedure or practice, which, if not strictly observed, could result in damage or destruction of equipment.
 WARNING!	Indicates a procedure or practice, which could result in injury to personnel or loss of life if not followed correctly.

SmartGen

# CONTENT

1	OVERVIEW.....	6
2	PERFORMANCE AND CHARACTERISTICS .....	7
3	SPECIFICATION .....	8
4	OPERATION .....	9
4.1	KEY FUNCTION DESCRIPTION .....	9
4.2	CONTROLLER PANEL.....	10
4.3	START/STOP OPERATION.....	10
4.3.1	START SEQUENCE.....	10
4.3.2	STOP SEQUENCE .....	10
4.4	START OPERATION FOR FUEL PRE-SUPPLY OUTPUT SETTING.....	11
4.5	EMERGENCY START .....	11
4.6	LOAD/UNLOAD SPEED REGULATION PROCESS OF AIR COMPRESSOR.....	11
5	MANUAL DPF REGENERATION .....	12
5.1	ILLUSTRATION.....	12
5.2	PANEL ICON DESCRIPTION OF DPF REGENERATION.....	13
5.3	DPF MANUAL REGENERATION OPERATION.....	13
6	PROTECTION .....	15
6.1	WARNINGS.....	15
6.2	SHUTDOWNS.....	16
7	WIRE CONNECTION .....	18
8	CONFIGURATION PARAMETER RANGE AND DEFINITION.....	20
8.1	PARAMETER RANGE AND DEFINITION .....	20
8.2	DEFINABLE CONTENTS OF AUXILIARY OUTPUT PORTS 1~6.....	29
8.2.1	DEFINABLE CONTENTS OF AUXILIARY OUTPUT PORTS 1~6 .....	29
8.2.2	CUSTOM PERIOD OUTPUT .....	33
8.2.3	DEFINED COMBINATION OUTPUT .....	33
8.3	DEFINED CONTENTS OF DIGITAL INPUT PORTS .....	34
8.4	SELECTION OF SENSORS .....	36
8.5	CONDITIONS OF CRANK DISCONNECT SELECTION .....	37
8.6	MAINTENANCE SETTING .....	37
9	PARAMETERS SETTING.....	38
10	SENSOR SETTING .....	40
11	COMMISSIONING .....	41
12	TYPICAL APPLICATION.....	41



---

13	INSTALLATION .....	42
13.1	CLIPS.....	42
13.2	OVERALL & CUTOUT DIMENSIONS .....	42
14	CONNECTIONS OF CONTROLLER WITH J1939 ENGINE .....	43
14.1	CUMMINS ISB/ISBE .....	43
14.2	CUMMINS QSL9 .....	43
14.3	CUMMINS QSM11(IMPORT) .....	44
14.4	CUMMINS QSX15-CM570.....	44
14.5	CUMMINS GCS-MODBUS.....	45
14.6	CUMMINS QSM11 .....	45
14.7	CUMMINS QSZ13.....	46
14.8	DETROIT DIESEL DDEC III / IV .....	46
14.9	DEUTZ EMR2 .....	47
14.10	JOHN DEERE .....	47
14.11	MTU MDEC .....	47
14.12	MTU ADEC (SMART MODULE).....	48
14.13	MTU ADEC (SAM MODULE).....	48
14.14	PERKINS.....	48
14.15	SCANIA .....	49
14.16	VOLVO EDC3 .....	49
14.17	VOLVO EDC4 .....	49
14.18	VOLVO-EMS2.....	50
14.19	YUCHAI.....	50
14.20	WEICHAI.....	50
15	TROUBLE SHOOTING.....	51
16	PACKING LIST .....	52

## 1 OVERVIEW

**ACC4100 Diesel Air Compressor Controller** is used for air compressor with diesel-driven engine in order to realize air compressor start/stop, data measurement, maintenance, alarm protection and “three remotes”. It has speed regulator function, and CANBUS (SAE J1939) port, which can control various ECU or non-ECU diesel air compressors.

**ACC4100 Diesel Air Compressor Controller** applies 32-bit ARM micro-processor technology, which can realize functions of precise measurement for many parameters, set-point adjustment, timing and threshold setting etc. A majority of parameters can be adjusted from the control panel. All parameters can be adjusted and monitored on PC by RS485 or USB port. It can be widely used for diesel-driven air compressor control system with compact structure, simple wiring, and high reliability.

SmartGen

## 2 PERFORMANCE AND CHARACTERISTICS

Main characteristics are as follows:

- 132x64 LCD display with backlit; Optional Chinese and English languages; Simple operation interface;
- Screen protection is hard screen of acrylic material with better wear-resisting and scratch resistant qualities;
- Silicon panel and buttons with strong adaptive capacity of high/low temperature environment;
- With RS485 communication port and can realize “three remotes” function by MODBUS protocol;
- CANBUS port can monitor ECU common data (speed, water temperature, oil pressure, engine load rate, fuel consumption etc.);
- DPF regeneration function, which meets Euro V emission standard;
- 6 ways of analog sensors, 3 ways of fixed resistance types, and 3 ways of flexible resistance/current/voltage type, which can precisely detect data of engine fuel level, air compressor discharge pressure, and discharge temperature etc;
- Multiple temperature, pressure, and level sensor curves can be used directly, and custom sensor curve is also available;
- Precisely collects all kinds of parameters of air compressor and has complete protection functions, which provides high water temperature, low oil pressure, over speed, and under speed protection, and discharge pressure high, discharge temperature high protection etc;
- Speed regulator function can automatically adjust speed according to discharge pressure of the air compressor;
- All outputs are relay outputs;
- Parameter setting function allows users to change and set the parameters, and at the same time they are stored in internal EEPROM memory and will not get lost at power outage;
- Crank disconnect conditions (speed, oil pressure) are optional;
- Speed can be obtained from speed sensor or charging generator W/L;
- Wide power supply range DC (8-35V), which can suit different battery voltage environment;
- Event log, real-time clock functions;
- Heater, cooler and fuel pump control functions;
- Maintenance function; maintenance time due action can be set;
- All parameters apply digital adjustment, getting rid of common potentiometer's analog regulation method, and improving reliability and stability of the whole device;
- Sealing gasket is designed for enclosure and front panel with IP65 protection class;
- Metal clips are used to fix the controller, and they are especially outstanding under high temperature environment;
- Modular design, anti-flaming ABS plastic shell, pluggable terminals, built-in mounting, compact structure and easy installation.

### 3 SPECIFICATION

**Table 3 Technical Parameters**









Items	Contents
Operating Voltage	DC8.0V~35.0V, continuous power supply
Power Consumption	<3W (Standby mode: ≤2W)
Speed Sensor Voltage	1.0V~24.0V (RMS)
Speed Sensor Frequency	Max. 10, 000Hz
Charging Generator W/L	Voltage (1.0-24.0)V (RMS)    Frequency (50-1,000)Hz
Starting Relay Output	5A    DC28V
Programmable Output 1	5A    DC28V
Programmable Output 2~6	1A    DC28V
Analog Sensor	3 ways of fixed resistance type (fuel level, programmable sensor 1, programmable sensor 2); 3 ways of flexible resistance/current/voltage types (discharge pressure, programmable sensor 3, programmable sensor 4);
Case Dimensions	135mm x 110mm x 44mm
Panel Cutout	116mm x 90mm
Working Conditions	Temperature: (-25~+70)°C;    Humidity: (20~93)%RH
Storage Condition	Temperature: (-25~+70)°C
Protection Level	IP65 front panel
Weight	0.35kg



## 4 OPERATION

### 4.1 KEY FUNCTION DESCRIPTION

**Table 4 Key Description**

Icon	Buttons	Function Description
	Start	Makes the air compressor start under stop state.
	Load/Unload	At idle speed state, press it and controller shall load and make relay output; at normal running state, press it again and controller shall unload and relay stops outputting.
	Alarm Reset	Press it and it enters alarm page fast; press it again and alarm is removed; after alarm reset, press it again and exit from alarm page.
	Maintenance	Press it and it enters maintenance page; press it again and exit from the page; press it longer at this page, it enters password interface; input password and maintenance setting is entered.
	Stop	<ol style="list-style-type: none"> <li>1. Stop the running air compressor at start mode;</li> <li>2. Press it for 3s or longer, test whether panel indicators are normal (lamp test);</li> <li>3. Press it again in stop process and controller can be stopped faster.</li> </ol>
	Up/Increase	<ol style="list-style-type: none"> <li>1. Scroll up;</li> <li>2. Move up cursor or increase the value in setting menu.</li> </ol>
	Down/Decrease	<ol style="list-style-type: none"> <li>1. Scroll down;</li> <li>2. Move down cursor or decrease the value in setting menu.</li> </ol>
	Set/Confirm	<ol style="list-style-type: none"> <li>1. In main screen, press it and it enters parameter setting menu;</li> <li>2. Confirm set information in parameter settings.</li> </ol>

## 4.2 CONTROLLER PANEL

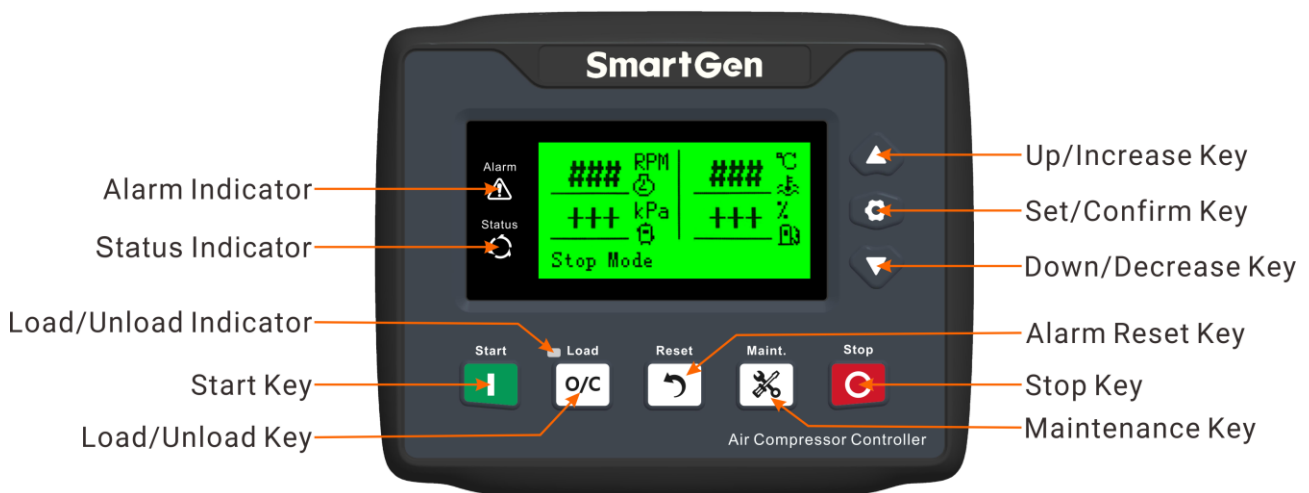

**Fig. 1 Front Panel Description**

**NOTE:** Description for parts of the indicators:

Alarm Indicator: slow flash (once per second) for warning alarm; quick flash (5 times per second) for stop alarm; light off for none alarms;

Status Indicator: it illuminates always as air compressor is normally running.

## 4.3 START/STOP OPERATION

### 4.3.1 START SEQUENCE

- Press  and start air compressor;
- If pre-heat time is configured, then pre-heat relay outputs (if configured); LCD displays "pre-heat delay xx";
- After pre-heat delay is over, fuel relay outputs the pre-set fuel time before start (default: 1s), then starting relay outputs; If air compressor crank disconnect fails during "crank time", then fuel relay and starting relay stop outputting, and enter "crank rest time", waiting for next start;
- After the pre-set start attempts, if air compressor doesn't succeed to start, then controller issues failed to start alarm, and meanwhile LCD alarm page displays "Failed to Start" alarm;
- During any one of the start attempts, if crank disconnect is fulfilled, then it enters "Safety On Delay", during which oil pressure low, water temperature high, under speed, and charging failure alarms are all inactive; after safety on delay it enters "Start Idle Delay" (if configured);
- During start idle delay, under speed alarm is inactive; after "Start Idle Time" it enters idle running; if load key is pressed, then load control outputs and it enters "Warming Up Time" (if configured);
- When warming up time is ended, air compressor enters normal running status; if speed is abnormal, controller shall issue alarms and stops it (LCD alarm page displays alarm information).

### 4.3.2 STOP SEQUENCE

- Press , and stop the running air compressor; before stop if load control outputs, then disconnect load control;
- If "Cooling Time" is configured, then "cooling delay" starts; when cooling delay is over, it enters

“Stop Idle Delay”;

- c) When it enters stop idle delay (if configured), then idle relay is energized to output;
- d) It enters “ETS Solenoid Hold”, and ETS relay is energized to output; fuel relay output is disconnected;
- e) It enters “Wait Stop Time”, and automatically judges whether it stops completely;
- f) When air compressor stops completely, it enters “After Stop Time”; Otherwise controller enters stop failure and issues “Stop Failure” warning (after the alarm, if air compressor stops completely, then it enters “After Stop Time”, and meanwhile “Stop Failure” alarm is removed automatically);
- g) When “After Stop Time” is over, it enters standby status.

#### 4.4 START OPERATION FOR FUEL PRE-SUPPLY OUTPUT SETTING



When output port is configured to “Fuel Pre-supply Output”, and press  to start the air compressor:

If the set pre-supply time is less than or equal to pre-heat time, LCD displays “Pre-heat Delay XX”, pre-heat relay outputs (if configured) and pre-supply relay outputs (output for the set pre-supply time); after pre-heat delay is over, fuel relay outputs the set fuel time (default: 1s) before start, then starting relay outputs; the following start process is the same as the START PROCEDURE (for start process please see 4.3.1, d)~g)).



If the set pre-supply time is more than the pre-heat time, pre-supply relay outputs in pre-heat delay phase; after pre-heat delay is over, the following pre-supply time enters pre-supply phase, and LCD displays “Fuel Pre-supply Time XX” and pre-supply relay outputs; after pre-supply delay is over, fuel relay outputs the pre-set fuel time (default: 1s) before start; then starting relay outputs; the following start process is the same as the START PROCEDURE (for start process please see 4.3.1 d)~g)).

If output port is configured to “Fuel Pre-supply Output”, air compressor stays at standby status and it outputs cyclically according to the pre-set “Fuel Pre-supply Rest Time” and “Fuel Pre-supply Time”; If the pre-set “Fuel Pre-supply Rest Time” is 0h, then fuel pre-supply doesn't output.

#### 4.5 EMERGENCY START

 **NOTE:** Press  and  simultaneously and air compressor can be started forcibly. At this time controller doesn't detect the unit crank disconnect by crank conditions. Starter's disconnect is controlled by the operator. When operator observes the unit has started, he/she should release the button. The starter stops outputting and controller enters Safety On Delay.

#### 4.6 LOAD/UNLOAD SPEED REGULATION PROCESS OF AIR COMPRESSOR

Under the state of idle running, press  and load control relay outputs. Controller enters normal running. If current discharge pressure is less than unloading action pressure, then engine speed goes up to rated speed. If current discharge pressure is larger than rated pressure, engine speed will decrease to unloading speed. Between rated pressure and unloading action pressure, speed decreases as pressure increases. Under normal running state, press  and load control relay disconnects and it enters idle running. Engine speed returns to rated idle value.

For example:

Engine rated speed: 2200RPM  
 Engine unloading speed value: 70% (1540RPM)  
 Engine idle value: 60% (1320RPM)  
 Air compressor rated pressure: 700kPa  
 Air compressor unloading action pressure: 600kPa

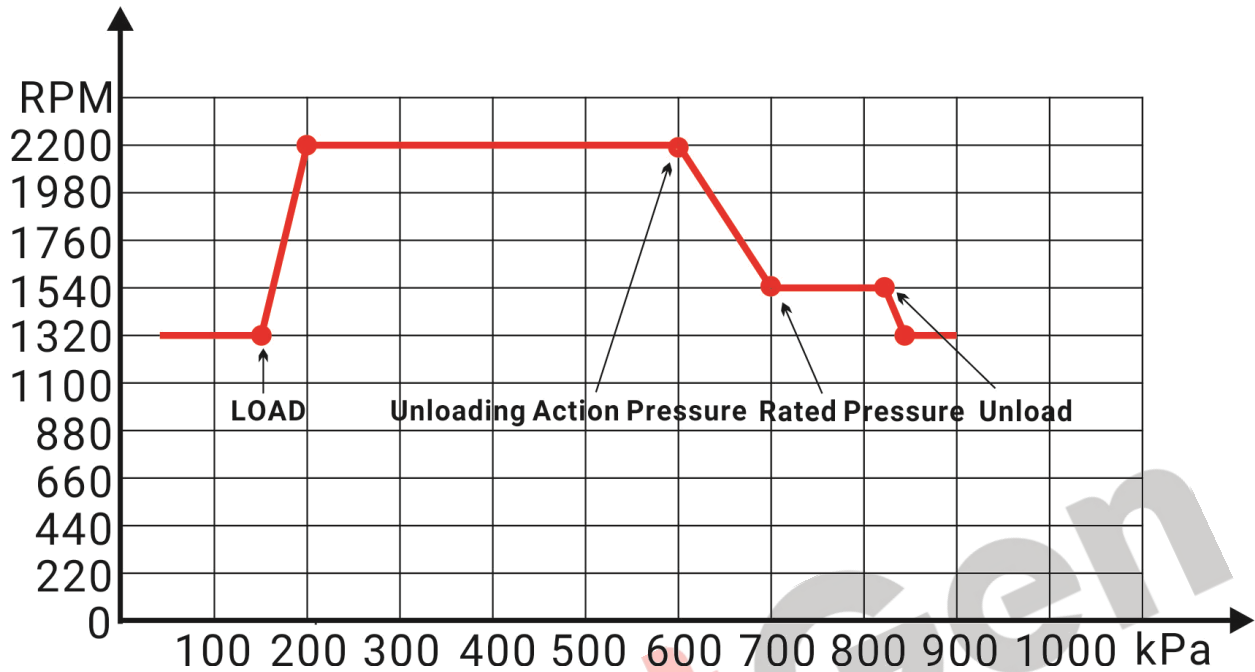

Fig. 2 Speed - Pressure Curve Diagram

## 5 MANUAL DPF REGENERATION

### 5.1 ILLUSTRATION







For engines meeting Euro V Standard, they all have DPF regeneration function.

Usually engine can clear the particulates in DPF by automatic regeneration function. However, engine usually is at short-time state, no-load running or low-speed low-load running state, automatic regeneration cannot completely clear out the DPF particulates, and there may appear particulate block, and beyond the limitation. Under this circumstance, manual DPF regeneration operation is needed.

Controller supports manual regeneration function, which meets the requirements of Euro V engine for controller. It can realize manual DPF regeneration operation.

## 5.2 PANEL ICON DESCRIPTION OF DPF REGENERATION

**Table 5 DPF Regeneration Panel Icon Description**

Icon	Description
	Engine fault indicator
	NCD state indicator
	DPF discharge temperature indicator
	DPF manual regeneration request indicator
	DPF regeneration inhibition indicator
	DPF regeneration response indicator

### 5.3 DPF MANUAL REGENERATION OPERATION

Configure an input port and set it to “DPF Manual Regeneration Request”, and connect a button (not self-lock) externally.

Press  on controller panel and enter parameter setting menu. Press  and select “DPF Regeneration”, and press  again to enter DPF regeneration. Controller display is as Fig. 3:

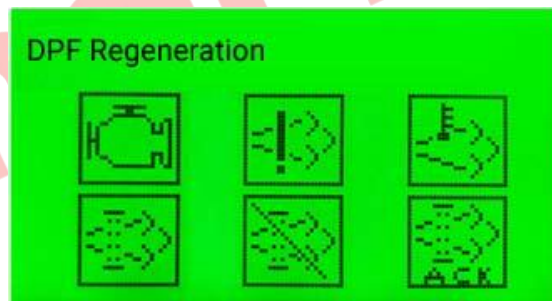

**Fig. 3 DPF Regeneration**

When manual regeneration is needed, press “DPF Manual Regeneration Request” button. On DPF panel, DPF response indicator is light on, and it enters DPF regeneration preparation status. When request indicator is always illuminated on the panel, and response indicator flashes at the same time (once per second), it means that regeneration preparation is well. Controller display is as Fig. 4:

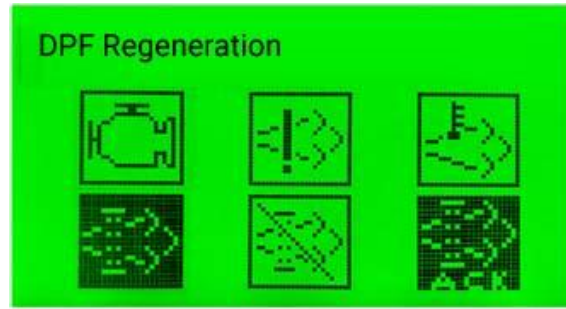

**Fig. 4 DPF Regeneration Preparation is Ready**

Press “DPF Manual Regeneration Request” again, and manual regeneration starts. DPF regeneration request indicator is light off, DPF response indicator is always light on and DPF discharge temperature indicator is always light on. Controller screen is as Fig. 5:

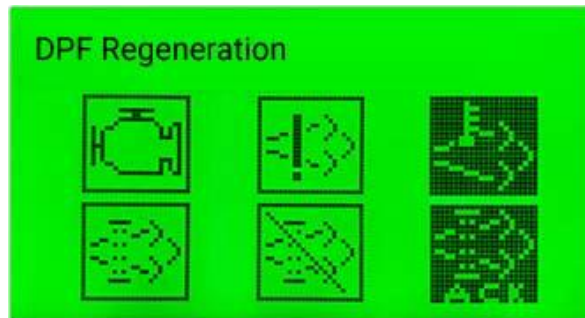

**Fig. 5 DPF Regeneration Start**

When manual regeneration is completed, DPF response indicator is light off, and DPF discharge temperature indicator is light off. Controller screen display is as Fig. 3 shows.

## 6 PROTECTION

### 6.1 WARNINGS

When controller detects warning signal, it only issues warning, not shutdown. When alarm is removed, warning alarm is cleared automatically.

**Table 6 Warnings**

No.	Type	Description
1	Over Speed Warn	When controller detects speed is above the pre-set over speed warning threshold, it issues warning signal.
2	Under Speed Warn	When controller detects speed is below the pre-set under speed warning threshold, it issues warning signal.
3	Loss of Speed Signal	When controller detects speed is 0, and speed signal loss action is selected "Warning", it issues warning signal.
4	Failed to Stop	When engine stop delay is over and engine doesn't stop completely, controller issues warning signal.
5	Charge Alt Fail	When controller detects engine charger voltage is less than pre-set threshold, it issues warning alarm signal.
6	Battery Overvoltage	When controller detects engine battery voltage is larger than pre-set threshold, it issues warning alarm signal.
7	Battery Undervoltage	When controller detects engine battery voltage is less than pre-set threshold, it issues warning alarm signal.
8	ECU Warn	When controller receives warning signal of engine by J1939, it issues warning signal.
9	Temp Sensor Open Warn	When controller detects sensor is open and action type is selected "Warning", it issues warning signal.
10	High Temp Warn	When controller detects temperature is higher than pre-set high temp warning value, it issues warning signal.
11	Low Temp Warn	When controller detects temperature is lower than pre-set low temp warning value, it issues warning signal.
12	OP Sensor Open Warn	When controller detects oil pressure sensor is open, and action type is selected "Warning", it issues warning signal.
13	Low OP Warn	When controller detects oil pressure value is below pre-set oil pressure warning value, it issues warning signal.
14	Fuel Level Open Warn	When controller detects fuel level sensor is open and action type is selected "Warning", it issues warning signal.
15	Low Fuel Level Warn	When controller detects level value is below pre-set fuel level warning value, it issues warning signal.
16	Discharge Pressure Open	When controller detects discharge pressure sensor is open and action type is selected "Warning", it issues warning signal.
17	High Discharge Press.	When controller detects discharge pressure value is above pre-set pressure warning value, it issues warning signal.
18	Low Discharge Press.	When controller detects discharge pressure value is below pre-set pressure warning value, it issues warning signal.





No.	Type	Description
19	Flexible Sensor 1~4 Open	When controller detects sensor is open, and action type is selected "Warning", it issues warning signal.
20	Flexible Sensor 1~4 High	When controller detects sensor value is above pre-set upper limit of warning values, it issues warning signal.
21	Flexible Sensor 1~4 Low	When controller detects sensor value is below pre-set lower limit of warning values, it issues warning signal.
22	Input 1~5 Warn	When digital input port is configured to "Warning", and when it is active, it issues corresponding input warning signal.
23	End of Mandate Time	When controller time reaches mandate time, and mandate time due action is selected "Warning", it issues warning signal.
24	Oil Filter Time Over	<p>When timing method is set to "Unit Running Time", maintenance timing is due, and action type is selected "Warning", it issues warning signal.</p> <p>When timing method is set to "Real Time Clock", maintenance countdown goes to 0, and action type is selected "Warning", it issues warning signal.</p>
25	Oil Separator Time Over	
26	Air Filter Time Over	
27	Lubrication Time Over	
28	Engine Oil Filter Over	
29	Engine Fuel Filter Over	
30	Engine Lubrication Over	
31	Maintenance 8 Over	
32	Maintenance 9 Over	
33	Maintenance 10 Over	

## 6.2 SHUTDOWNS

When controller detects shutdown alarm signal, it immediately stops. When engine stops completely, it needs to press manually Alarm Reset button to remove alarms.

**Table 7 Shutdown Alarms**

No.	Type	Description
1	Emergency Stop	When controller detects emergency stop alarm signal, it issues emergency stop alarm signal.
2	Engine Overspeed Shut	When controller detects engine speed is over preset over speed stop threshold, it issues shutdown alarm signal.
3	Engine Underspeed Shut	When controller detects engine speed is below preset under speed stop threshold, it issues shutdown alarm signal.
4	Loss of Speed Signal	When controller detects speed is 0, and speed signal loss action is selected "Shutdown", it issues shutdown alarm signal.
5	Failed to Start	When engine fails to start during pre-set start attempts, controller issues failed to start alarm signal.
6	ECU Shutdown	When controller receives shutdown alarm signal via J1939, it issues shutdown alarm signal.
7	High Temp. Shutdown	When controller input port is set to High Temp Shutdown Input and if it is active, it issues alarm signal.
8	Low Oil Press Shutdown	When controller input port is set to Low Oil Pressure Shutdown





No.	Type	Description
		Input and if it is active, it issues alarm signal.
9	ECU Comm. Failure	When engine start is completed, but controller doesn't receive data via J1939, controller issues communication failure signal.
10	Temp Sensor Open Shut	When controller detects sensor open, and action type is selected "Shutdown", it issues shutdown alarm signal.
11	High Temp Shutdown	When controller detects temperature value is above pre-set shutdown value, it issues shutdown alarm signal.
12	OP Sensor Open Shut	When controller detects sensor is open and action type is selected "Shutdown", it issues shutdown alarm signal.
13	Low OP Shutdown	When controller detects oil pressure is below pre-set shutdown value, it issues shutdown alarm signal.
14	Fuel Level Open Shut	When controller detects sensor is open, and action type is "Shutdown", it issues shutdown alarm signal.
15	Low Fuel Level Shutdown	When controller detects level is below pre-set fuel level shutdown value, it issues shutdown alarm signal.
16	Discharge Pressure Open	When controller detects pressure sensor is open, and action type is selected "Shutdown", it issues shutdown alarm signal.
17	High Discharge Press	When controller detects sensor is above pre-set pressure shutdown value, it issues shutdown alarm signal.
18	Low Discharge Press	When controller detects sensor is below pre-set pressure shutdown value, it issues shutdown alarm signal.
19	Flexible Sensor 1~4 Open	When controller detects sensor is open, and action type is selected "Shutdown", it issues shutdown alarm signal.
20	Flexible Sensor 1~4 High	When controller detects sensor value is above pre-set upper shutdown limit value, it issues shutdown alarm signal.
21	Flexible Sensor 1~4 Low	When controller detects sensor value is below pre-set lower shutdown limit value, it issues shutdown alarm signal.
22	Input 1~5 Shutdown	When digital input is configured to shutdown alarm, and if it is active, it issues corresponding input shutdown alarm signal.
23	End of Mandate Time	When controller time reaches mandate time, and mandate time due action is selected "Warning", it issues warning signal.
24	Oil Filter Time Over	<p>When timing method is set to "Unit Running Time", maintenance timing is due, and action type is selected "Shutdown", it issues shutdown signal.</p> <p>When timing method is set to "Real Time Clock", maintenance countdown goes to 0, and action type is selected "Shutdown", it issues shutdown signal.</p>
25	Oil Separator Time Over	
26	Air Filter Time Over	
27	Lubrication Time Over	
28	Engine Oil Filter Over	
29	Engine Fuel Filter Over	
30	Engine Lubrication Over	
31	Maintenance 8 Over	
32	Maintenance 9 Over	
33	Maintenance 10 Over	

**NOTE:** For ECU Warning and ECU Shutdown alarms, if detailed information is displayed, check the engine according

to the information; otherwise refer to engine user manual to obtain information according to SPN alarm code.

## 7 WIRE CONNECTION

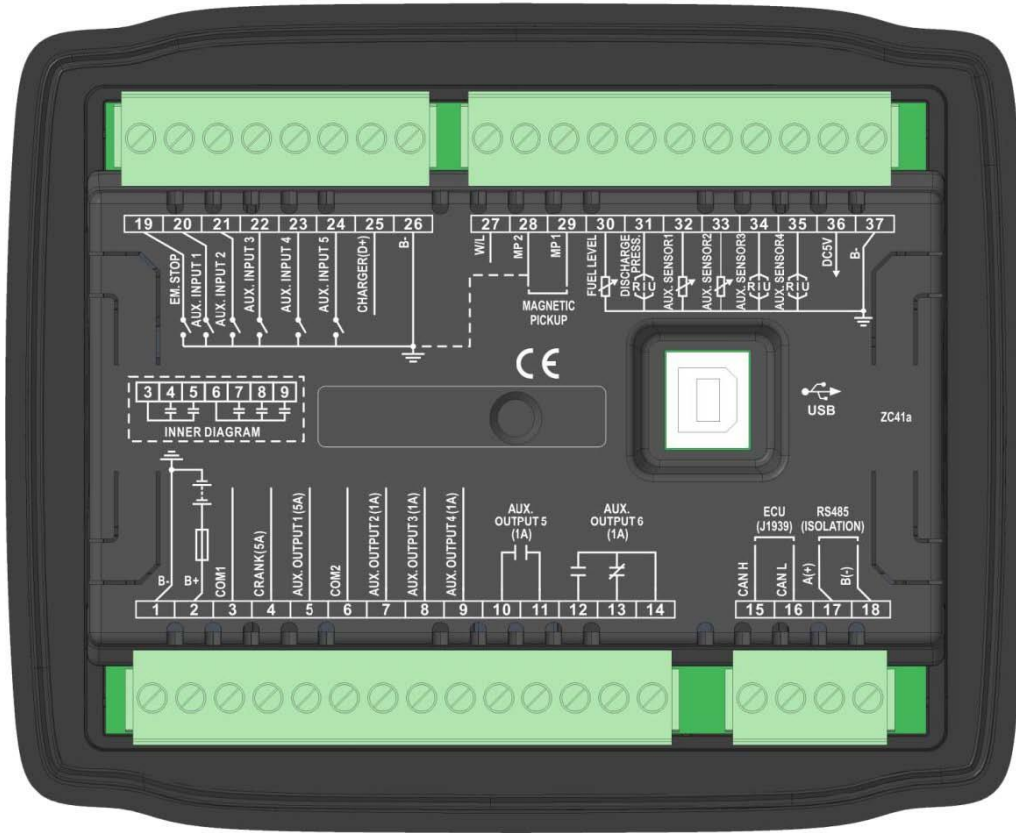

**Fig. 6 Controller Back Panel**

**Table 8 Connection Terminal Description**

No.	Function	Cable Size	Remark
1	DC Power Input B-	1.5mm <sup>2</sup>	Connects starter battery negative;
2	DC Power Input B+	1.5mm <sup>2</sup>	Connects starter battery positive;
3	COM1 Relay	1.5mm <sup>2</sup>	Connects COM1 output, Rated 5A DC28V;
4	Crank Relay Output	1.0mm <sup>2</sup>	
5	AUX. Output 1	1.0mm <sup>2</sup>	
6	COM2 Relay	1.0mm <sup>2</sup>	Connects COM2 output, Rated 1A DC28V;
7	AUX. Output 2	1.0mm <sup>2</sup>	
8	AUX. Output 3	1.5mm <sup>2</sup>	
9	AUX. Output 4	1.5mm <sup>2</sup>	N/O volts free contact, Rated 1A DC28V;
10	AUX. Output 5	1.0mm <sup>2</sup>	
11		1.0mm <sup>2</sup>	
12	AUX. Output 6	1.0mm <sup>2</sup>	N/O output, Rated 1A DC28V;

Please see Table 10 for setting items.



No.	Function	Cable Size	Remark	
13		1.0mm <sup>2</sup>	N/C output, Rated 1A DC28V;	
14		1.0mm <sup>2</sup>	Relay COM	
15	ECU CAN H	0.5mm <sup>2</sup>	Resistance 120Ω shielding wire is recommended; single end is ground connected.	
16	ECU CAN L	0.5mm <sup>2</sup>		
17	RS485 A(+)	0.5mm <sup>2</sup>		
18	RS485 B(-)	0.5mm <sup>2</sup>		
19	EM. Stop	0.5mm <sup>2</sup>	When it is active, controller shall do emergency stop.	
20	Aux. Input 1	0.5mm <sup>2</sup>	Active when ground connected (B-);	Please see Table 11 for setting items.
21	Aux. Input 2	0.5mm <sup>2</sup>	Active when ground connected (B-);	
22	Aux. Input 3	0.5mm <sup>2</sup>	Active when ground connected (B-);	
23	Aux. Input 4	0.5mm <sup>2</sup>	Active when ground connected (B-);	
24	Aux. Input 5	0.5mm <sup>2</sup>	Active when ground connected (B-);	
25	Charger D+	1.0mm <sup>2</sup>	Connects charger D+ (W/L) terminal; hung up it if the terminal doesn't exist.	
26	Aux. Input COM	0.5mm <sup>2</sup>	Connected already with B- internally;	
27	W/L	0.5mm <sup>2</sup>	Connects charger W;	
28	MP2 Speed Sensor Input; Connected with battery negative already internally;	0.5mm <sup>2</sup>	Connects engine speed sensor; shielding wire is recommended;	
29	MP1 Speed Sensor Input	0.5mm <sup>2</sup>		
30	Fuel Level Sensor	1.0mm <sup>2</sup>	Connects engine fuel level sensor (resistance);	Please see Table 12 for setting items.
31	Discharge Press. Sensor	1.0mm <sup>2</sup>	Connects discharge pressure sensor (resistance/current/voltage);	
32	Aux. Sensor 1	1.0mm <sup>2</sup>	Users-defined (resistance)	
33	Aux. Sensor 2	1.0mm <sup>2</sup>	Users-defined (resistance)	
34	Aux. Sensor 3	1.0mm <sup>2</sup>	Users-defined (resistance/current/voltage)	
35	Aux. Sensor 4	1.0mm <sup>2</sup>	Users-defined (resistance/current/voltage)	
36	DC5V	1.0mm <sup>2</sup>	Power supply for voltage sensor;	
37	Sensor COM (B-)	1.0mm <sup>2</sup>	Sensor COM; connected with B- already internally;	
	USB	/	Communication with PC monitoring software.	

## 8 CONFIGURATION PARAMETER RANGE AND DEFINITION

### 8.1 PARAMETER RANGE AND DEFINITION

Table 9 Parameter Setting Contents and Range List

No.	Item	Range	Default	Description
Language				
1	Language	(0-1)	0	0: Simplified Chinese 1: English
Override Mode				
1	Override Mode	(0-1)	0	0: Disable 1: Enable
LCD Backlight				
1	Contrast Ratio	(0-10)	5	Set LCD contrast ratio;
2	Brightness	(0-5)	5	Set LCD backlight brightness;
3	Delay	(0-3600)min	5	Backlight is always on when delay is set to 0min.
Module Setting				
1	Module Address	(1-254)	1	Controller address for remote monitoring;
2	Comm. Stop Bit	(0-1)	0	0: 2-bit Stop Bit 1: 1-bit Stop Bit (PC software settings)
3	Password	(0-9999)	1234	It used for advanced parameter setting; <b>⚠Caution!</b> Default password is "1234"; It can be changed by operator for purpose of preventing others changing controller advanced configuration. If password is changed, please remember clearly. If it is forgotten, please contact company service person.
4	Date and Time			Users can calibrate date and time.
5	Maintain Password	(0-9999)	1234	Independent password for maintenance.
Timer Setting				
1	Preheat Delay	(0-3600)s	0	Time for pre-heating plug to be energized before starter is energized.
2	Prestart Fuel Time	(0-3600)s	1	Time for fuel relay output every time before starter is energized.
3	Cranking Time	(3-60)s	8	Time for starter to be energized every time.
4	Crank Rest Time	(3-60)s	10	Waiting time before second energization when engine fails to start.
5	Safety On Delay	(0-3600)s	10	During this time oil pressure low, temp. high, under speed, under frequency, under voltage, and charge alt failure alarms are all inactive.
6	Start Idle Time	(0-3600)s	10	Time for engine idle running in start process.



No.	Item	Range	Default	Description
7	Warming Up Time	(0-3600)s	0	Warming up time for engine before normal running after high speed running.
8	Cooling Time	(0-3600)s	0	Cooling time before stop
9	Stop Idle Time	(0-3600)s	10	Time for engine idle running in stop process.
10	ETS Solenoid Hold	(0-3600)s	20	Time for ETS to be energized before stop.
11	Wait Stop Time	(0-3600)s	0	Time after idle running delay before complete stop when ETS Solenoid Hold is set 0; When it is not 0, it is time after ETS delay before complete stop.
12	After Stop Time	(0-3600)s	0	Time from complete stop to standby status.
13	Fuel Pre-supply Rest Time	(0-12)h	2	Interval time from this pre-supply is completed to next pre-supply is outputted when output is configured to fuel pre-supply in standby state; when it is set to 0, pre-supply will not output in standby state.
14	Fuel Pre-supply Time	(3-30)s	5	Time for pre-supply output when output is configured to fuel pre-supply.
<b>Engine Setting</b>				
1	Engine Type	(0-39)	34	Default: 34: GTSC1;
2	Enable ECU Alarm Shut	(0-1)	1	0: Disable 1: Enable <b>NOTE:</b> When engine detects red light alarm, it will stop when it is enabled;
3	Source of Speed Signal	(0-1)	0	0: Speed Sensor 1: W/L
4	W/L Ratio	(0-99.99)	9.04	
5	Flywheel Teeth	(1.0-300.0)	118.0	Flywheel teeth of engine, used for starter disconnect conditions and engine speed detection; please refer to the below installation.
6	Rated Speed	(0-6000)r/min	2200	Provide standard for over speed, under speed and load speed detection.
7	Start Attempts	(1-10)times	3	Maximum start times in case of failed start; when this number is reached, controller shall issue Failed to Start signal.
8	Crank Disconnect	(0-2)	2	Please refer to Table 12; There are two kinds of disconnect conditions for engine and starter. They can be used independently or together and the purpose is to separate starter motor and engine as soon as possible.
9	Disconnect Speed	(0-200)%	24	Set value is the percentage of rated speed; when speed is above the set value, starter



No.	Item	Range	Default	Description	
				shall disconnect; Please refer to the rear installation.	
10	Disconnect OP	(0-1000)kPa	200	When Oil Pressure is above pre-set value, starter shall disconnect. Please refer to the rear installation.	
11	Overspeed Warn	Set	(0-200.0)%	110.0	Set value is the percentage of rated speed; Return value and delay value can also be set.
		Return	(0-200.0)%	108.0	
		Delay	(0-3600)s	5	
12	Underspeed Warn	Set	(0-200.0)%	55.0	
		Return	(0-200.0)%	60.0	
		Delay	(0-3600)s	5	
13	Overspeed Shutdown	Set	(0-200.0)%	114.0	Set value is the percentage of rated speed; Delay value can also be set.
		Delay	(0-3600)s	2	
14	Underspeed Shutdown	Set	(0-200.0)%	50.0	
		Delay	(0-3600)s	3	
15	Loss of Speed Signal Delay	(0-3600)s	5	Time from detecting speed is 0 to confirm the action;	
16	Loss of Speed Signal Action	(0-1)	0	0: Warning 1: Shutdown	
17	Battery Rated Voltage	(0-60.0)V	24.0	Provide standard for battery over/under voltage detection.	
18	Battery Overvolt Warn	Set	(0-200)%	120	Set value is the percentage of battery rated voltage; Return value and delay value can also be set.
		Return	(0-200)%	115	
		Delay	(0-3600)s	60	
19	Battery Undervolt Warn	Set	(0-200)%	85	
		Return	(0-200)%	90	
		Delay	(0-3600)s	60	
20	Charge Alt Fail	Set	(0-60.0)V	8.0	During engine normal running process, when charger D+ voltage is below this value, controller issues charge alt fail warning.
		Return	(0-60.0)V	10.0	
		Delay	(0-3600)s	10	
21	Engine Idle Speed	(0-100)%	70	Set value is the percentage of rated speed; when idle running is needed, stabilize the speed at the set value.	
22	Engine Unload Speed	(0-100)%	70	Set value is the percentage of rated speed; when discharge pressure reaches rated pressure after load, stabilize the speed at the set value.	
23	Air Com. Rated Pressure	(0-30000)kPa	700	Adjust speed at corresponding upper pressure value after load.	
24	Air Com. Unload Act Press	(0-30000)kPa	600	Adjust speed at corresponding lower pressure value after load.	





No.	Item	Range	Default	Description
25	Raise Speed Rate Set	(30-500)r/s	150	Increased number of turns per second;
26	Drop Speed Rate Set	(30-500)r/s	30	Reduced number of turns per second;
27	Load Valve Auto Control	(0-1)	0	0: Disable 1: Enable When the non-ECU unit setting is enabled, press the load key after that, if discharge pressure is less than air compressor unload action pressure, load control outputs; if discharge pressure is larger than air compressor rated pressure, load control stops outputting.
28	Charger Voltage Source	(0-1)	0	0: ECU 1: Analog
29	Charger Excitation Control	(0-1)	0	0: Disable 1: Enable When it is disabled, D+ control doesn't output.
Analog Sensor Setting				
Engine Temperature (ECU) Setting				
1	Display Unit	(0-1)	0	0: °C; 1: °F
2	Over Shutdown	((-50)-300)°C	98	When external temp. sensor value is larger than this value, controller issues temp. high shutdown alarm; This value is detected only after safety on delay. Delay value can be set.
3	Over Warn	((-50)-300)°C	95	When external temp. sensor value is over this value, controller issues temp. high shutdown alarm; This value is detected only after safety on delay. Return and delay value can be set.
4	Under Warn	((-50)-300)°C	70	When external temp. sensor value is less than this value, controller issues temp. low warning alarm; This value is detected always. Delay value and return value can be set.
5	Heater Control	((-50)-300)°C	50	When external temp. sensor value is less than this value, heater control outputs. Delay value and return value can be set.
6	Cooler Control	((-50)-300)°C	80	When external temp. sensor value is larger than this value, cooler control outputs. Delay value and return value can be set.

No.	Item	Range	Default	Description
<b>Engine Oil Pressure (ECU) Setting</b>				
1	Display Unit	(0-2)	0	0: kPa 1: bar 2: psi
2	OP Low Shutdown	(0-1000)kPa	103	When external oil pressure sensor value is less than this value, controller issues OP low shutdown alarm. This value is detected only after safety on delay. Delay value can be set.
3	OP Low Warn	(0-1000)kPa	124	When external oil pressure sensor value is less than this value, controller issues OP low warning alarm. This value is detected only after safety on delay. Delay value and return value can be set.
<b>Fuel Level Sensor Setting</b>				
1	Curve Type	(0-15)	4	SGD; For details please refer to Table 12.
2	Open Action	(0-2)	0	0: Warning 1: Shutdown 2: None
3	Display Unit	(0-1)	0	0: % 1: L
4	Under Shutdown	(0-300)%	10	When external sensor value is less than this value, controller issues shutdown alarm; Alarm enable and delay value can be set.
5	Under Warn	(0-300)%	20	When external sensor value is less than this value, controller issues warning alarm; Alarm enable, return and delay value can be set.
6	Fuel Pump Control	(0-300)%	10	When external fuel level sensor value is less than this value, fuel pump control outputs; return value and delay value can also be set.
7	Fuel Tank Capacity Set	(0-10000)L	1000	
8	Custom Curve			When custom resistance is chosen in the curve type, corresponding curve shall be set.
<b>Discharge Pressure Sensor Setting</b>				
1	Curve Type	(0-15)	2	Custom 4-20mA curve; Please refer to Table 12 for details.
2	Open Action	(0-2)	0	0: Warning 1: Shutdown 2: None
3	Display Unit	(0-2)	0	0: kPa 1: bar 2: psi
4	Over Shutdown	(0-30000)kPa	2500	When external sensor value is larger than this value, controller issues shutdown alarm; Alarm enable and delay value can be set.
5	Under Shutdown	(0-30000)kPa	100	When external sensor value is less than this value, controller issues shutdown alarm; alarm enable and delay value can be





No.	Item	Range	Default	Description
				set.
6	Over Warn	(0-30000)kPa	2000	When external sensor value is larger than this value, controller issues warning alarm; alarm enable, return and delay values can be set.
7	Under Warn	(0-30000)kPa	200	When external sensor value is less than this value, controller issues warning alarm; alarm enable, return and delay values can be set.
8	Custom Curve			When custom resistance/current/voltage types are selected; related curve needs to be set.
<b>Flexible Sensor 1~4 Setting</b>				
1	Sensor Type	(0-3)	0	0: Not Used 1: Engine Temperature Sensor 2: Engine Oil Pressure Sensor 3: Temperature Sensor 4: Oil Pressure Sensor 5: Level Sensor
2	Curve Type			Changes according to sensor types;
3	Open Action	(0-2)	0	0: Warning 1: Shutdown 2: None
4	Display Unit	(0-1)	0	0: °C 1: °F <b>NOTE:</b> Unit is different for different sensor.
5	Over Shutdown	(0-9000)	100	When external sensor value is larger than this value, controller issues shutdown alarm; Alarm enable and delay value can be set.
6	Under Shutdown	(0-9000)	10	When external sensor value is less than this value, controller issues shutdown alarm; alarm enable and delay value can be set.
7	Over Warn	(0-9000)	90	When external sensor value is larger than this value, controller issues warning alarm; alarm enable, return and delay values can be set.
8	Under Warn	(0-9000)	20	When external sensor value is less than this value, controller issues warning alarm; alarm enable, return and delay values can be set.
9	Custom Curve			When custom resistance/current/voltage types are selected; related curve needs to be set.
<b>Engine Temperature Related Setting</b>				
1	Sensor Correlate Set	(0-4)	0	0: Not Used 1: Flexible Sensor 1

No.	Item	Range	Default	Description
				2: Flexible Sensor 2 3: Flexible Sensor 3 4: Flexible Sensor 4
2	Heater Control	((-50)-300)°C	50	When the external temp. sensor value is less than this value, heater control outputs; Return and delay value can be set.
3	Cooler Control	((-50)-300)°C	80	When the external temp. sensor value is higher than this value, cooler control outputs; Return and delay value can be set.
<b>Engine Oil Pressure Related Setting</b>				
1	Sensor Correlate Set	(0-4)	0	0: Not Used 1: Flexible Sensor 1 2: Flexible Sensor 2 3: Flexible Sensor 3 4: Flexible Sensor 4
<b>Discharge Temp. Display Related Setting</b>				
1	Sensor Correlate Set	(0-4)	0	0: Not Used 1: Flexible Sensor 1 2: Flexible Sensor 2 3: Flexible Sensor 3 4: Flexible Sensor 4
<b>Digital Input Ports</b>				
<b>Digital Input 1</b>				
1	Contents Setting	(0-53)	3	Alarm Reset; Please refer to Table 11 for details.
2	Active Type	(0-1)	0	0: Close 1: Open
<b>Digital Input 2</b>				
1	Contents Setting	(0-53)	26	High Temp. Shutdown Input; Please refer to Table 11 for details.
2	Active Type	(0-1)	0	0: Close 1: Open
<b>Digital Input 3</b>				
1	Contents Setting	(0-53)	27	Low Oil Pressure Shutdown Input; Please refer to Table 11 for details.
2	Active Type	(0-1)	0	0: Close 1: Open
<b>Digital Input 4</b>				
1	Contents Setting	(0-53)	0	Users defined; Please refer to Table 11 for details.
2	Active Type	(0-1)	0	0: Close 1: Open
3	Active Range	(0-3)	2	0: From Safety On 1: From Crank 2: Always 3: Never
4	Active Action	(0-2)	0	0: Warning 1: Shutdown 2: Indication
5	Active Delay	(0-20.0)s	2.0	Time from detecting input is active to

No.	Item	Range	Default	Description
				confirm;
6	Input Description			Users defined;
<b>Digital Input 5</b>				
1	Contents Setting	(0-53)	0	Users defined; Please refer to Table 11 for details.
2	Active Type	(0-1)	0	0: Close 1: Open
3	Active Range	(0-3)	2	0: From Safety On 1: From Crank 2: Always 3: Never
4	Active Action	(0-2)	0	0: Warning 1: Shutdown 2: Indication
5	Active Delay	(0-20.0)s	2.0	Time from detecting input is active to confirm;
6	Input Description			Users defined;
<b>Auxiliary Outputs</b>				
<b>Auxiliary Output 1</b>				
1	Contents Setting	(0-129)	29	Fuel relay output; Please refer to Table 10 for details.
2	Output Type	(0-1)	0	0: Normally Open 1: Normally Close
<b>Auxiliary Output 2</b>				
1	Contents Setting	(0-129)	28	Starting relay output; Please refer to Table 10 for details.
2	Output Type	(0-1)	0	0: Normally Open 1: Normally Close
<b>Auxiliary Output 3</b>				
1	Contents Setting	(0-129)	30	Idle speed control; Please refer to Table 10 for details.
2	Output Type	(0-1)	0	0: Normally Open 1: Normally Close
<b>Auxiliary Output 4</b>				
1	Contents Setting	(0-129)	26	Load control; Please refer to Table 10 for details.
2	Output Type	(0-1)	0	0: Normally Open 1: Normally Close
<b>Auxiliary Output 5</b>				
1	Contents Setting	(0-129)	39	Normal running output; Please refer to Table 10 for details.
2	Output Type	(0-1)	0	0: Normally Open 1: Normally Close
<b>Auxiliary Output 6</b>				
1	Contents Setting	(0-129)	42	Common alarm; Please refer to Table 10 for details.
2	Output Type	(0-1)	0	0: Normally Open

No.	Item	Range	Default	Description
				1: Normally Close
<b>Alternate Configuration Setting</b>				
<b>Alternate Configuration 1</b>				
1	Enable Choose	(0-1)	0	0: Disable 1: Enable
2	Engine Rated Speed	(0-6000)r/min	2200	When this is enabled, if input is configured to "Alt Config. 1 Active", and if input is active, speed shall be adjusted according to alternate configuration settings after load.
3	Engine Unload Speed	(0-100.0)%	70.0	
4	Air Com. Rated Pressure	(0-30000)kPa	700	
5	Air Com. Unload Act Press	(0-30000)kPa	600	
<b>Alternate Configuration 2</b>				
1	Enable Choose	(0-1)	0	0: Disable 1: Enable
2	Engine Rated Speed	(0-6000)r/min	2200	When this is enabled, if input is configured to "Alt Config. 2 Active", and if input is active, speed shall be adjusted according to alternate configuration settings after load.
3	Engine Unload Speed	(0-100.0)%	70.0	
4	Air Com. Rated Pressure	(0-30000)kPa	700	
5	Air Com. Unload Act Press	(0-30000)kPa	600	
<b>Alternate Configuration 3</b>				
1	Enable Choose	(0-1)	0	0: Disable 1: Enable
2	Engine Rated Speed	(0-6000)r/min	2200	When this is enabled, if input is configured to "Alt Config. 3 Active", and if input is active, speed shall be adjusted according to alternate configuration settings after load.
3	Engine Unload Speed	(0-100.0)%	70.0	
4	Air Com. Rated Pressure	(0-30000)kPa	700	
5	Air Com. Unload Act Press	(0-30000)kPa	600	
<b>Maintenance Setting</b>				
1	Oil Filter Set	(0-1)	0	0: Disable 1: Enable Maintenance time, maintenance time due action, maintenance timing method, maintenance time reset can also be set at the same time; After maintenance, maintenance time due alarm can be removed by resetting maintenance time; Please refer to Table 14 for details.
2	Oil Separator Set	(0-1)	0	
3	Air Filter Set	(0-1)	0	
4	Lubrication Set	(0-1)	0	
5	Engine Oil Filter Set	(0-1)	0	
6	Engine Fuel Filter Set	(0-1)	0	
7	Engine Lubrication Set	(0-1)	0	
8	Maintenance 8 Set	(0-1)	0	
9	Maintenance 9 Set	(0-1)	0	
10	Maintenance 10 Set	(0-1)	0	

**NOTES:**

- Regarding parameter setting on PC software, it isn't needed to input default factory password "1234" if not changed; if it is the first time to do configuration on PC, then it is needed to input module password in password screen;
- Digital input ports cannot be set the same items (except for user-defined). Otherwise function shall not work correctly; Output ports can be set the same item;
- Engine temperature related settings: if it is ordinary engine and engine temperature is needed, any one of flexible sensors 1~4 shall be set engine temperature sensor; and at the same time curve type shall be set the

corresponding one; Next is to set engine temperature related sensor; Select corresponding flexible sensor, which is engine temperature sensor at this time, heater control and cooler control can be realized. If alarm output function will be set, corresponding flexible sensor output shall be set;

- Engine oil pressure related settings: if it is conventional engine and it is needed to use engine oil pressure to judge crank disconnect, if it is ordinary engine and it is needed to use engine oil pressure to judge crank disconnect, any one of the flexible sensors 1~4 shall be set engine oil pressure, meanwhile curve type shall be set to the corresponding one. Then set engine oil pressure related sensor; Choose corresponding sensor, and at this time oil pressure is displayed, which can be one of the crank disconnect conditions; if alarm output function will be set, corresponding flexible sensor output shall be set;
- Discharge temperature display related settings: if discharge temperature is needed to display in the first page of main screen, then any one of the flexible sensors 1~4 shall be set temperature, and at the same time curve type shall be set corresponding curve; Then set discharge temperature display related setting; Choose corresponding sensor, and at this time first page shall have discharge temperature. If alarm output function will be set, corresponding flexible sensor output shall be set.

## 8.2 DEFINABLE CONTENTS OF AUXILIARY OUTPUT PORTS 1~6

### 8.2.1 DEFINABLE CONTENTS OF AUXILIARY OUTPUT PORTS 1~6

**Table 10 Definable Contents of Auxiliary Output Ports 1~6**

No.	Type	Function Description
0	Not Used	
1	Custom Period 1	Please refer to the following contents for function details.
2	Custom Period 2	
3	Custom Period 3	
4	Custom Period 4	
5	Custom Period 5	
6	Custom Period 6	
7	Custom Combined 1	
8	Custom Combined 2	
9	Custom Combined 3	
10	Custom Combined 4	
11	Custom Combined 5	
12	Custom Combined 6	
13	Reserved	
14	Reserved	
15	Air Flap Control	Act at the time of over speed shutdown alarm and emergency stop; Air flap can be closed to realize fast stop.
16	Audible Alarm	Act at the time of warning and shutdown alarms; Annunciator can be connected externally; It can be inhibited to output when input port "Alarm Mute" is active or any key is pressed; When there is new warning or shutdown alarm, it outputs again.
17	Louver Control	Act at the time of engine start; Disconnect after engine stop.
18	Fuel Pump Control	Act by fuel pump control upper and lower limits of fuel level sensor.
19	Heater Control	Act by heater control upper and lower limits of temp. sensor.



No.	Type	Function Description
20	Cooler Control	Act by cooler control upper and lower limits of temp. sensor.
21	Fuel Pre-supply	Under standby state, fuel pre-supply output port is active and it outputs circularly according to pre-set "Fuel Pre-supply Rest Time" and "Fuel Pre-supply Time"; If "Fuel Pre-supply Rest Time" is 0h, then it doesn't output; Before start, pre-set pre-supply time is outputted; If pre-heat time is not configured, pre-supply outputs; If pre-heat time is configured, then pre-heat phase outputs.
22	Reserved	
23	Pre-lubricate	Act at the phase of pre-heating, fuel, start, and start rest time.
24	Remote Control	Controlled by communication port RS485.
25	Reserved	
26	Load Control	Load/Unload key is pressed or load control input is active, then load control outputs; If load/unload key is pressed again or load input is inactive, then load control stops outputting.
27	Reserved	
28	Starting Relay	Act at engine start; and disconnect after successful start.
29	Fuel Relay	Act at engine start; and disconnect at ETS stop.
30	Idle Control	Used for engine with idle speed; Pull in before start, and disconnect at entering warming up time; Pull in at the process of stop idle speed, and disconnect when engine stops completely.
31	Speed Raise Output	Act in warming up period, and controlled by speed regulator in normal running period.
32	Speed Drop Output	Act from stop idle to waiting for stop period and controlled by speed regulator in normal running period.
33	Energize to Stop	Used for engine with stop ETS; Pull in when stop idle speed is over, and disconnect when pre-set "ETS Solenoid Hold" is over.
34	Run Key Switch Control	Used for checking ECU data once at power on; it outputs once it is power on; it stops outputting the signal at ETS stop time and failed to stop time;.
35	ECU Stop	Applicable for engine supporting ECU, and used to control ECU stop.
36	ECU Power Supply	Applicable for engine supporting ECU, and used to control ECU power.
37	Reserved	
38	Crank Success	Pull in when it detects crank success signal.
39	Normal Running	Pull in and output when it is in normal running period.
40	Reserved	
41	Reserved	
42	Common Alarm	Act at the time of common alarm and common shutdown.
43	Common Shutdown	Act at the time of common shutdown.
44	Common Warning	Act at the time of common warning.
45	Reserved	
46	Battery Overvolt	Act when battery voltage high warning occurs.



No.	Type	Function Description
47	Battery Undervolt	Act when battery voltage low warning occurs.
48	Failed to Charge	Act when failed to charge warning occurs.
49	Reserved	
50	ECU Warning	ECU issued a warning alarm signal.
51	ECU Shutdown	ECU issued a shutdown alarm signal.
52	ECU Comm. Failure	Controller cannot communicate with ECU.
53	Reserved	
54	NCD Lamp Output	DPF regeneration related lamp outputs of Euro V engine.
55	Regen Req Lamp	
56	Regen Inhibit Lamp	
57	Discharge Temp Lamp	
58	Regen Response Lamp	
59	Input 1 Active	Act when input port 1 is active.
60	Input 2 Active	Act when input port 2 is active.
61	Input 3 Active	Act when input port 3 is active.
62	Input 4 Active	Act when input port 4 is active.
63	Input 5 Active	Act when input port 5 is active.
64	Reserved	
65	Reserved	
66	Reserved	
67	Emergency Stop	Act when emergency stop alarm occurs.
68	Failed to Start	Act when failed to start alarm occurs.
69	Failed to Stop	Act when failed to stop alarm occurs.
70	Under Speed Warn	Act when engine under speed warning occurs.
71	Under Speed Shutdown	Act when engine under speed shutdown occurs.
72	Over Speed Warn	Act when engine over speed warning occurs.
73	Over Speed Shutdown	Act when engine over speed shutdown occurs.
74	Reserved	
75	Reserved	
76	Load Control 1	When "Alt Config. 1 Active" is active, under normal running state, load control 1 outputs.
77	Load Control 2	When "Alt Config. 2 Active" is active, under normal running state, load control 2 outputs.
78	Load Control 3	When "Alt Config. 3 Active" is active, under normal running state, load control 3 outputs.
79	High Temp Warning	Act when high temp. warning alarm occurs.
80	Low Temp Warning	Act when low temp. warning alarm occurs.
81	High Temp Shutdown	Act when high temp. shutdown alarm occurs.
82	Reserved	
83	Engine Low OP Warn	Act when low oil pressure warning occurs.
84	Engine Low OP Shut	Act when low oil pressure shutdown occurs.
85	Reserved	
86	Reserved	
87	Reserved	





No.	Type	Function Description
88	Low Fuel Level Warn	Act when low fuel level warning occurs.
89	Reserved	
90	Low Fuel Level Shut	Act when low fuel level shutdown occurs.
91	Reserved	
92	Reserved	
93	High Discharge Pressure Warn	Act when discharge pressure high warning occurs.
94	Low Discharge Pressure Warn	Act when discharge pressure low warning occurs.
95	High Discharge Pressure Shut	Act when discharge pressure high shutdown occurs.
96	Low Discharge Pressure Shut	Act when discharge pressure low shutdown occurs.
97	Flexible Sensor 1 High Warn	Act when sensor 1 high warning occurs.
98	Flexible Sensor 1 Low Warn	Act when sensor 1 low warning occurs.
99	Flexible Sensor 1 High Shut	Act when sensor 1 high shutdown occurs.
100	Flexible Sensor 1 Low Shut	Act when sensor 1 low shutdown occurs.
101	Flexible Sensor 2 High Warn	Act when sensor 2 high warning occurs.
102	Flexible Sensor 2 Low Warn	Act when sensor 2 low warning occurs.
103	Flexible Sensor 2 High Shut	Act when sensor 2 high shutdown occurs.
104	Flexible Sensor 2 Low Shut	Act when sensor 2 low shutdown occurs.
105	Flexible Sensor 3 High Warn	Act when sensor 3 high warning occurs.
106	Flexible Sensor 3 Low Warn	Act when sensor 3 low warning occurs.
107	Flexible Sensor 3 High Shut	Act when sensor 3 high shutdown occurs.
108	Flexible Sensor 3 Low Shut	Act when sensor 3 low shutdown occurs.
109	Flexible Sensor 4 High Warn	Act when sensor 4 high warning occurs.
110	Flexible Sensor 4 Low Warn	Act when sensor 4 low warning occurs.
111	Flexible Sensor 4 High Shut	Act when sensor 4 high shutdown occurs.
112	Flexible Sensor 4 Low Shut	Act when sensor 4 low shutdown occurs.
113	Reserved	
114	Reserved	
115	Reserved	
116	Reserved	
117	Reserved	
118	Reserved	
119	Reserved	



### 8.2.2 CUSTOM PERIOD OUTPUT

Defined period output is composed by 2 parts: period output S1 and condition output S2.



S1 and S2 both are true, then it outputs; S1 or S2 is false, it doesn't output;

Period output S1 can be configured randomly to one, or several period outputs; Delay time and output time after entering period can be set;

Condition output S2 can be any contents of output settings.

**▲NOTE:** When period output S1 delay time and output time are both 0, configurations of period output S1 are both true.

Output period: Start

Delay output time: 2s

Output time: 3s

Condition output contents: Input 1 is active;

Condition output active/inactive close; close when active (disconnect when inactive)

When input port 1 is active, and it enters start time and delays for 2s, custom period output starts to output, after outputting for 3s, it stops outputting;

When input port 1 is inactive, custom output doesn't output.

### 8.2.3 DEFINED COMBINATION OUTPUT

Defined combination output is composed by 3 parts: OR condition output S1, OR condition output S2, AND condition output S3.

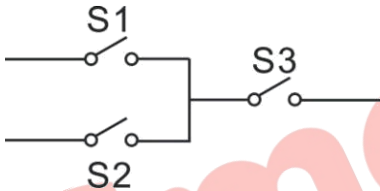

S1 or S2 is true, and S3 is true, then combination output works.

S1 and S2 both are false, or S3 is false, then combination output doesn't work.

**▲NOTE:** S1, S2 and S3 can be any contents except itself defined combination output of the output settings.

**▲NOTE:** S1, S2 and S3 cannot include or recursively include itself.

Contents of OR condition output S1: output port 1 is active;

Close when OR condition output S1 is active/inactive: close when active (disconnect when inactive);

Contents of OR condition output S2, output port 2 is active;

Close when OR condition output S2 is active/inactive: close when active (disconnect when inactive);

Contents of AND condition output S3: output port 3 is active;

Close when AND condition output S3 is active/inactive: close when active (disconnect when inactive);

When input port 1 is active or input port 2 is active, if input port 3 is active, defined combination output is working; if input port 3 is inactive, defined combination output is not working;

When input port 1 is inactive and port 2 is inactive, no matter port 3 is active or not, defined combination output is not working.

### 8.3 DEFINED CONTENTS OF DIGITAL INPUT PORTS

**Table 11 Defined Contents of Digital Input Ports**

No.	Type	Description
0	Users Configured	Users can define the following functions: Indication: indicate only, not warning or shutdown. Warning: warning only, not shutdown. Shutdown: alarm and shutdown immediately Never: input is inactive. Always: input is active all the time. From crank: start to detect at the time of start. From safety on: start to detect after safety on run delay.
1	Reserved	
2	Alarm Mute	Can prohibit output configurations "Audible Alarm" outputs when input is active.
3	Alarm Reset	Can reset shutdown alarm when input is active.
4	Reserved	
5	Lamp Test	All LED indicators are illuminated when input is active.
6	Panel Lock	All buttons in panel is inactive except UP/DOWN/CONFIRM keys. Parameters cannot be configured. But users can set language, check event log and controller information. There is  in the bottom right corner on LCD when input is active.
7	Crank Success Input	When this function is active, it means the engine is started successfully. If this function is configured, the speed and oil pressure of crank success conditions will be invalid.
8	Reserved	
9	Reserved	
10	Reserved	
11	Reserved	
12	Reserved	
13	Reserved	
14	Reserved	
15	Reserved	
16	DPF Manual Regen. Request	A button can be connected externally (not self-lock); For engine with Euro V standard, if PDF regeneration is needed, press the button and controller shall issue manual request command to ECU.
17	DPF Regeneration Inhibit	For engine with Euro V standard, if DPF regeneration Inhibit is needed, so when input is active, controller issues inhibition command to ECU.
18	Reserved	
19	Reserved	
20	Reserved	

No.	Type	Description
21	Alarm Stop Inhibit	All shutdown alarms are inhibited except emergency stop and over speed shutdown. (Override mode)
22	Instrument Mode	All outputs are inhibited in this mode.
23	Reserved	
24	Reset Maintenance	Controller will set the time and date of maintenance 1 as default value when input is active.
25	External Charging Failure	When input is active, failed to charge warning alarm occurs.
26	High Temp Shutdown	Connects to sensor digital input.
27	Low OP Shutdown	Connects to sensor digital input.
28	Reserved	
29	Reserved	
30	Reserved	
31	Reserved	
32	Manual Start Input	When input is active, engine can be started automatically; when input is inactive, engine can be stopped automatically.
33	Reserved	
34	Simulate Stop key	An external button (unlatched) can be connected and pressed as simulate panel.
35	Simulate Load/Unload key	An external button (unlatched) can be connected and pressed as simulate panel.
36	Reserved	
37	Simulate Start key	An external button (unlatched) can be connected and pressed as simulate panel.
38	Reserved	
39	Reserved	
40	Reserved	
41	Reserved	
42	Alt Config. 1 Active	When input port is active, configuration is active; Different parameters can be set for it, making convenience for users to choose current configuration by input port.
43	Alt Config. 2 Active	
44	Alt Config. 3 Active	
45	Reserved	
46	Reserved	
47	Load Input	Act between start idle and stop idle; When input is active, load control outputs; When it is inactive, load control stops outputting.
48-53	Reserved	

## 8.4 SELECTION OF SENSORS

**Table 12 Sensors Selection**

No.	Items	Description	Remark
1	Temperature Sensor	0 Not used 1 Custom Res Curve 2 Custom (4-20)mA Curve 3 Custom Volt Curve 4 VDO 5 CURTIS 6 VOLVO-EC 7 DATCON 8 SGX 9 SGD 10 SGH 11 PT100 12 Cu50 13-15 Reserved	Defined resistance's range is (0~1)kΩ, default is "Not Used"; Users can select the corresponding curve by themselves; If pre-set sensor channel doesn't support current, and voltage type, then curve type item 2 and 3 display "Reserved".
2	Oil Pressure Sensor	0 Not used 1 Custom Res Curve 2 Custom (4-20)mA Curve 3 Custom Volt Curve 4 VDO 10bar 5 CURTIS 6 VOLVO-EC 7 DATCON 10bar 8 SGX 9 SGD 10 SGH 11 -15 Reserved	Defined resistance's range is (0~1)kΩ, default is "Not Used"; Users can select the corresponding curve by themselves; If pre-set sensor channel doesn't support current, and voltage type, then curve type item 2 and 3 display "Reserved".
3	Fuel Level Sensor	0 Not used 1 Custom Res Curve 2 Custom (4-20)mA Curve 3 Custom Volt Curve 4 SGD 5 SGH 6 -15 Reserved	Defined resistance's range is (0~1)kΩ, default is "Not Used"; Users can select the corresponding curve by themselves; If pre-set sensor channel doesn't support current, and voltage type, then curve type item 2 and 3 display "Reserved".

## 8.5 CONDITIONS OF CRANK DISCONNECT SELECTION

**Table 13 Crank Disconnect Conditions**

No.	Setting Description
0	Engine Speed
1	Oil pressure
2	Oil pressure + Engine Speed

**NOTES:**

- There are 2 conditions to make starter disconnected with engine. Engine speed and oil pressure can be used separately. We recommend that oil pressure should be used with speed sensor together, in order to make the starter motor separate with engine immediately and can check crank disconnect exactly;
- Speed sensor is the magnetic equipment installed in starter for detecting flywheel teeth;
- When set it speed sensor, users must ensure that the number of flywheel teeth is the same as settings, otherwise, “over speed shutdown” or “under speed shutdown” may be caused;
- If engine doesn't have speed sensor please don't select corresponding items, otherwise, “start failure” or “loss speed signal” may be caused;
- If engine doesn't have oil pressure sensor, please don't select corresponding items.

## 8.6 MAINTENANCE SETTING

**Table 14 Maintenance Setting**

Item	Content	Description
Enable Choose	0: Disabled, 1: Enabled	Set maintenance function active or not;
Maintenance Time	(0-30000)h	It is the number of hours from the time the maintenance is enabled to when maintenance is required.
Maintenance Due Action	0: No Action; 1: Warning; 2: Shutdown; 3: Indication.	Alarm action when maintenance left time is 0.
Maint. Timing Method	0: Running Time 1: Real Time Clock	The timing of maintenance.
Reset Maintenance		After maintenance completion, through this item reset maintenance time.
Maintenance Description		The character string of maintenance description can be set by maintenance 8, 9 and 10; Users can input maintenance name, like Change Engine Oil.

## 9 PARAMETERS SETTING

Press  key and enter into setting menu after controller is power on. The menu list is as below:

- >Return
- >Parameters Set
- >Override Mode
- >DPF Regeneration
- >Language
- >LCD Backlight
- >Event Log
- >Module Info



Select "Parameters Set" and input correct password (default: 1234) to enter setting interface.

Parameter setting process is as below:

Parameters Set >Return >Module Set >Timers Set	Screen 1: Enter setting, press   to change settings, press  to enter setting (Screen 2), press  to return. Or select "Return" by pressing  and  and press  to go back to previous screen.
>Engine Set	
Timers Set >Return >Preheat Delay	Screen 2: Press   to change settings, press  to enter setting (Screen 3), press  to return (Screen 1). Or select "Return" by pressing  and  and press  to go back to the previous screen 1.
>Prestart Fuel Time >Cranking Time	
Preheat Delay 0000s	Screen 3: Press  and move cursor, select the value and press   to modify. Press  to save your modification. Then press  to return (Screen 2).
Timers Set >Return >Preheat Delay >Prestart Fuel Time >Cranking Time	Screen 4: Press  , select and modify the value (it is the same method as Screen 2 and Screen 3).
Over Shutdown Enable Choose: Enabled Set Val: +00098 Delay 00003s	Screen 5: Set temp. sensor shutdown parameters. Select >Over Shutdown, press  to enter setting, then press  again to enter Screen 5, press   to select settings, then press  to save and meanwhile the cursor will move down (as Screen 6).
Over Shutdown Enable Choose: Enabled	Screen 6: Press   to change plus or minus, then press  to

Set Val:

Delay

next bit. After setting finished, press  to enter delay setting. If it is not need to modify, press  to return.

**NOTES:**

- Please modify internal parameters (eg: Crank disconnect conditions, programmable input/output configuration, delay, etc) in standby status, otherwise it probably shutdowns or faults may occur;
- Over high threshold must be greater than lower threshold, otherwise over high and over low circumstances may occur simultaneously;
- Please set return value correctly when warning alarm is set, otherwise the controller can't alarm normally. When over warning is set, the return value should be set lower than set value; when low warning is set, return value should be set greater than set value;
- Programmable inputs can't be set the same item (except for user-defined), otherwise it won't arise valid function. But programmable outputs can be set the same.

SmartGen

## 10 SENSOR SETTING

- If a sensor is needed to change again, the sensor curve will be transferred into the standard value. For example, if the default temperature sensor is SGD, the sensor curve is SGD curve; if it is set SGX, the temperature sensor curve is SGX curve.
- If there is difference between standard sensor curve and the used sensor, users can choose “defined sensor”, and input defined sensor curve.
- At the time of inputting the sensor curve, X value must be inputted from small to large, otherwise, some mistake may occur.
- If sensor is selected to “Not Used”, then sensor curve doesn't work.
- If corresponding sensor only has alarm switch, then it is a must that set the sensor “Not Used”, otherwise shutdown alarm or warning may occur.
- It is applicable to set the headmost and backmost values in the vertical coordinate as the same as the Figure 7.

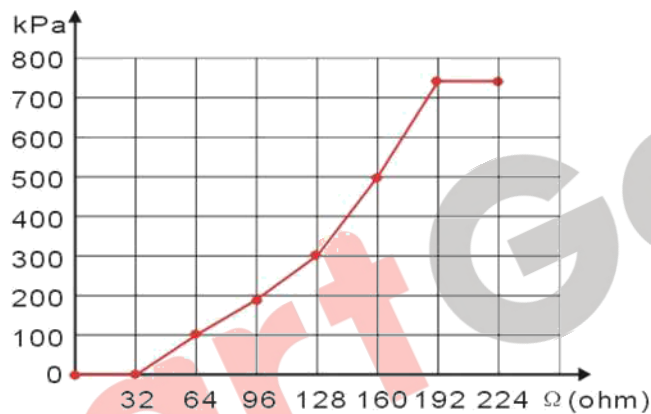

**Fig. 7 Sensor Curve Setting**

**Table 15 Common Pressure Unit Conversion Table**

Item	N/m <sup>2</sup> (pa)	kgf/cm <sup>2</sup>	bar	(p/in <sup>2</sup> .psi)
1Pa	1	1.02x10 <sup>-5</sup>	1x10 <sup>-5</sup>	1.45x10 <sup>-4</sup>
1kgf/cm <sup>2</sup>	9.8x10 <sup>4</sup>	1	0.98	14.2
1bar	1x10 <sup>5</sup>	1.02	1	14.5
1psi	6.89x10 <sup>3</sup>	7.03x10 <sup>-2</sup>	6.89x10 <sup>-2</sup>	1



## 11 COMMISSIONING

It is suggested to do the following examination before formal system operation:

- Check all the connections are correct and wire diameter is suitable.
- Ensure that controller DC power has fuse, controller's positive and negative are correctly connected to starting battery.
- Take proper action to prevent engine from crank disconnect (e. g. Remove the connection wire of fuel valve). If everything is OK, make the starting battery power on and controller will execute routine.
- Press "start" button, engine will start. After pre-set start times, controller will send failed to start signal; then press "stop" button to reset controller.
- Recover the action of stop engine start (e. g. Connect wire of fuel valve), and press start button again, then engine will start. If everything goes well, engine will go to normal running after idle running (if idle running is set). During this time, please observe engine's running situation.
- If there is any other question, please contact SmartGen's service.

## 12 TYPICAL APPLICATION

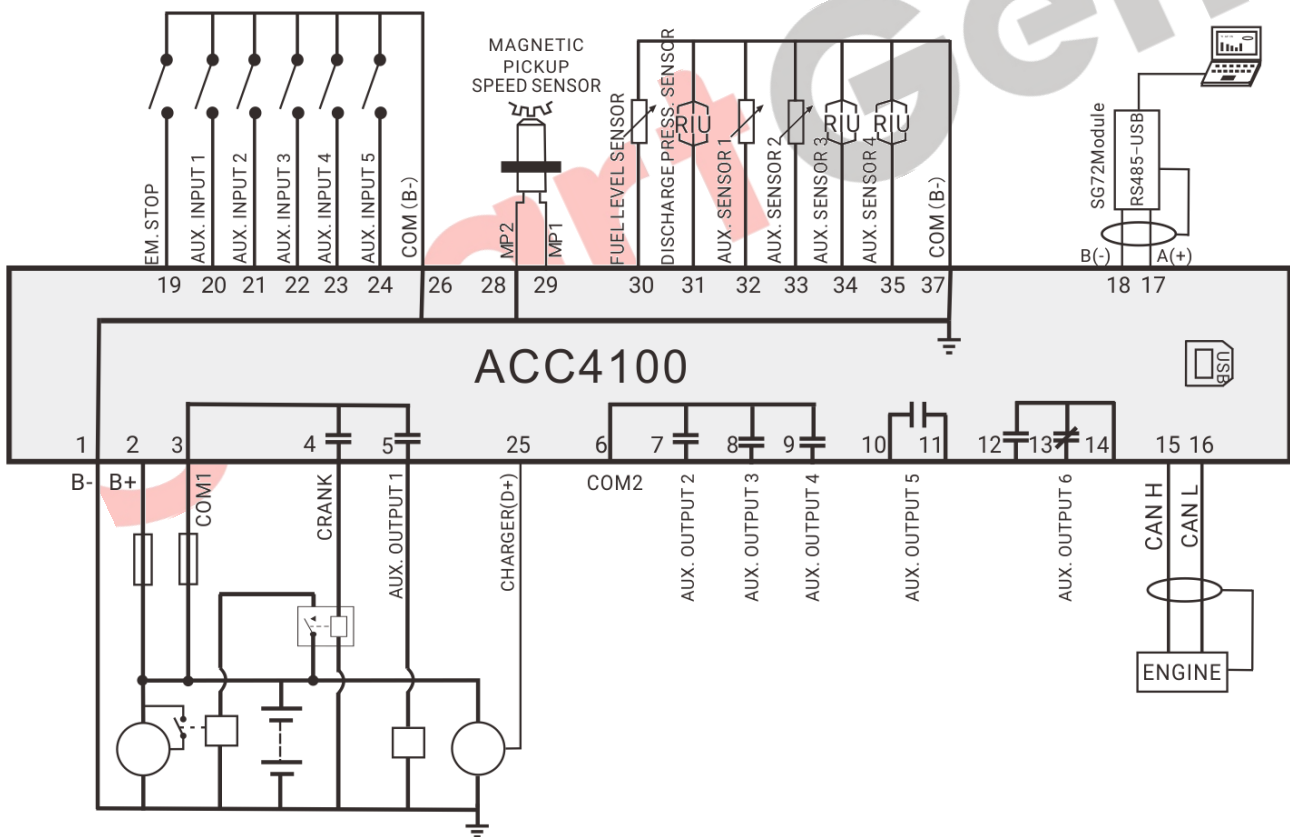

**Fig. 8 ACC4100 Typical Application Diagram**

## 13 INSTALLATION

### 13.1 CLIPS

Controller is panel built-in design; and it is fixed by clips for installation.

- Withdraw the fixing clip screws (anticlockwise) until they reach proper position;
- Pull the fixing clips backwards (towards the back of the module) and ensure two clips are inside their allotted slots;
- Turn the fixing clip screws clockwise steady until they are fixed on the panel.

**NOTE:** Care should be taken not to over tighten the screws of the fixing clips.

### 13.2 OVERALL & CUTOUT DIMENSIONS

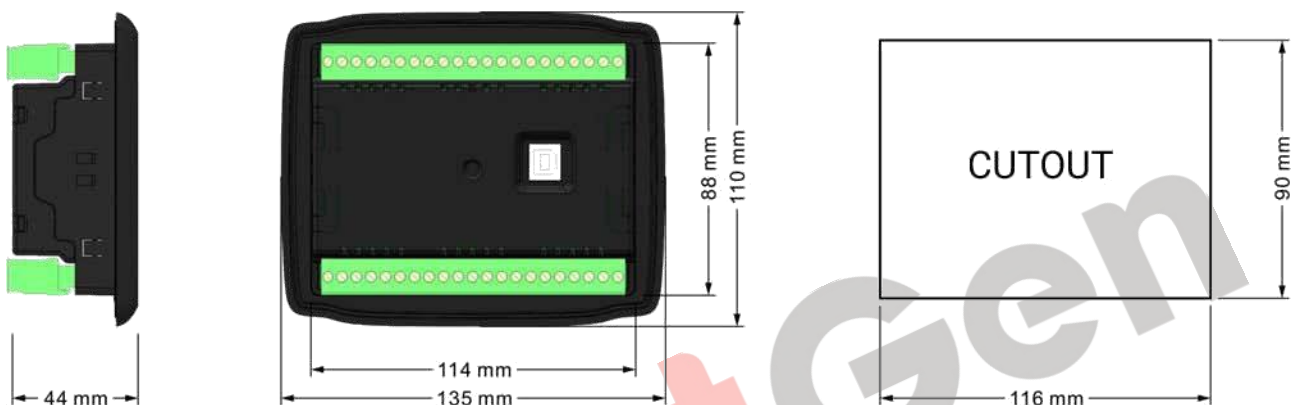

**Fig. 9 Overall & Cutout Dimensions**

- **BATTERY VOLTAGE INPUT:** ACC4100 controller can suit battery voltage environment of DC (8~35)V. Negative of battery must be connected with the engine shell. Diameter of wire which connects power supply B+ and B- with battery positive and negative must be over 1.5mm<sup>2</sup>. If floating charger is configured, please firstly connect output wires of the charger to battery's positive and negative directly, then connect wires from battery's positive and negative to controller's positive and negative input ports in order to prevent charger disturbing the controller's normal working;
- **SPEED SENSOR INPUT:** Speed sensor is the magnetic equipment installed in the starter for detecting flywheel teeth. The connection wires with controller should apply 2-core shielding line. The shielding layer should be connected to No. 28 terminal in the controller and another side is hanging up in the air. The other two signal wires are connected to No. 28 and No. 29 terminals. The output voltage of speed sensor should be within AC (1~24)V (effective value) during the full speed range. AC12V is recommended (at rated speed). When speed sensor is installed, let the sensor spun to contacting flywheel first, then, port out 1/3 lap, and lock the nuts of sensor at last;
- **OUTPUT AND EXPAND RELAYS:** All controller outputs are relay contact output type. If expansion relay is needed, please add freewheel diode to both ends of expansion relay's coils (when relay coils have DC current) or, increase resistance-capacitance return circuit (when relay coils have AC current), in order to prevent disturbance to the controller or other equipment.

## 14 CONNECTIONS OF CONTROLLER WITH J1939 ENGINE

### 14.1 CUMMINS ISB/ISBE

Engine type: Cummins ISB.

**Table 16 Connector B**

Terminals of controller	Connector B	Remark
Fuel relay output	39	
Starting relay output	-	Connect with starter coil directly.
Auxiliary output port 1	Expansion 30A relay, providing battery voltage for 01, 07, 12, 13 terminals.	ECU power; Set configurable output 1 as "ECU power".

**Table 17 9-pin Connector**

Terminals of controller	9 pins connector	Remark
-	SAE J1939 shield	CAN communication shielding line (connect with ECU terminal only).
CAN(H)	SAE J1939 signal	Impedance 120Ω connecting line is recommended.
CAN(L)	SAE J1939 return	Impedance 120Ω connecting line is recommended.

### 14.2 CUMMINS QSL9

Suitable for CM850 engine control module; Engine type: Cummins-CM850.

**Table 18 50-pin Connector**

Terminals of controller	50 pins connector	Remark
Fuel relay output	39	
Starting relay output	-	Connect to starter coil directly.

**Table 19 9-pin Connector**

Terminals of controller	9 pins connector	Remark
-	SAE J1939 shield-E	CAN communication shielding line (connect with ECU terminal only).
CAN(H)	SAE J1939 signal-C	Using impedance 120Ω connecting line.
CAN(L)	SAE J1939 return-D	Using impedance 120Ω connecting line.

### 14.3 CUMMINS QSM11(IMPORT)

Suitable for CM570 engine control module; Engine type is QSM11 G1, QSM11 G2; Engine type: Cummins ISB.

**Table 20 C1 Connector**

Terminals of controller	C1 connector	Remark
Fuel relay output	5&8	Outside extended relay, make port 5 and port 8 of C1 connected at fuel output;
Starting relay output	-	Connect to starter coil directly.

**Table 21 3-pin Data Link Connector**

Terminals of controller	3 pins data link connector	Remark
-	C	CAN communication shielding line (connect with ECU terminal only).
CAN(H)	A	Using impedance 120Ω connecting line.
CAN(L)	B	Using impedance 120Ω connecting line.

### 14.4 CUMMINS QSX15-CM570

Suitable for CM570 engine control module; Engine type is QSX15 etc. Engine type: Cummins QSX15-CM570.

**Table 22 50-pin Connector**

Terminals of controller	50 pins connector	Remark
Fuel relay output	38	Oil spout switch.
Starting relay output	-	Connect to starter coil directly.

**Table 23 9-pin Connector**

Terminals of controller	9 pins connector	Remark
-	SAE J1939 shield-E	CAN communication shielding line (connect with ECU terminal only).
CAN(H)	SAE J1939 signal-C	Using impedance 120Ω connecting line.
CAN(L)	SAE J1939 return-D	Using impedance 120Ω connecting line.

## 14.5 CUMMINS GCS-MODBUS

Suitable for GCS engine control module; Use RS485-MODBUS to read information of engine. Engine types are QSX15, QST30, QSK23/45/60/78 and so on.

Engine type: Cummins QSK-Modbus, Cummins QST-Modbus, Cummins QSX-Modbus.

**Table 24 D-SUB Connector 06**

Terminals of controller	D-SUB connector 06	Remark
Fuel relay output	5&8	Outside extended relay, make port 5 and 8 of connector 06 connected at fuel output.
Starting relay output	-	Connect to starter coil directly.

**Table 25 D-SUB Connector 06**

Terminals of controller	D-SUB connector 06	Remark
-	20	Communication shielding line (connect with ECU this terminal only).
RS485+	21	Using impedance 120Ω connecting line.
RS485-	18	Using impedance 120Ω connecting line.

## 14.6 CUMMINS QSM11

Engine type: Common J1939.

**Table 26 Engine OEM Connector**

Terminals of controller	OEM connector of engine	Remark
Fuel relay output	38	
Starting relay output	-	Connect with starter coil directly.
CAN(H)	46	Using impedance 120Ω connecting line.
CAN(L)	37	Using impedance 120Ω connecting line.

## 14.7 CUMMINS QSZ13

Engine type: Cummins-QSZ13; Speed governing can be realized.

**Table 27 Engine OEM Connector**

Terminals of controller	OEM connector of engine	Remark
Fuel relay output	45	
Starting relay output	-	Connect to starter coil directly.
Auxiliary output 1	16&41	Idle speed control, normally close output. Make 16 connected with 41 during high-speed running via external extended relay.
Auxiliary output 2	19&41	Pulse speed raising control, normally open output. Make 19 connected with 41 for 0.1s during warming up via external extended relay.
CAN(H)	1	Using impedance 120Ω connecting line.
CAN(L)	21	Using impedance 120Ω connecting line.

## 14.8 DETROIT DIESEL DDEC III / IV

Engine type: Common J1939.

**Table 28 Engine CAN Port**

Terminals of controller	CAN port of engine	Remark
Fuel relay output	Expansion 30A relay, providing battery voltage for ECU.	
Starting relay output	-	Connect to starter coil directly.
CAN(H)	CAN(H)	Using impedance 120Ω connecting line.
CAN(L)	CAN(L)	Using impedance 120Ω connecting line.

## 14.9 DEUTZ EMR2

Engine type: Volvo-EDC4.

**Table 29 F Connector**

Terminals of controller	F connector	Remark
Fuel relay output	Expansion 30A relay, providing battery voltage for 14; Fuse is 16A.	
Starting relay output	-	Connect to starter coil directly.
-	1	Connect to battery negative pole.
CAN(H)	12	Impedance 120Ω connecting line is recommended.
CAN(L)	13	Impedance 120Ω connecting line is recommended.

## 14.10 JOHN DEERE

Engine type: John Deere.

**Table 30 21-pin Connector**

Terminals of controller	21 pins connector	Remark
Fuel relay output	G, J	
Starting relay output	D	
CAN(H)	V	Using impedance 120Ω connecting line.
CAN(L)	U	Using impedance 120Ω connecting line.

## 14.11 MTU MDEC

Suitable for MTU engines, 2000 series, 4000series; Engine type: mtu-MDEC-303.

**Table 31 X1 Pin Connector**

Terminals of controller	X1 connector	Remark
Fuel relay output	BE1	
Starting relay output	BE9	
-	E	Communication shielding line (connect with ECU this terminal only).
CAN(H)	G	Using impedance 120Ω connecting line.
CAN(L)	F	Using impedance 120Ω connecting line.

#### 14.12 MTU ADEC (SMART MODULE)

Suitable for MTU engine with ADEC (ECU8) and SMART module; Engine type: mtu-ADEC.

**Table 32 ADEC (X1 Port)**

Terminals of controller	ADEC (X1port)	Remark
Fuel relay output	X1 10	X1 Terminal 9 connected to negative of battery.
Starting relay output	X1 34	X1 Terminal 33 connected to negative of battery.

**Table 33 ADEC (X4 Port)**

Terminals of controller	SMART (X4 port)	Remark
CAN(H)	X4 1	Using impedance 120Ω connecting line.
CAN(L)	X4 2	Using impedance 120Ω connecting line.

#### 14.13 MTU ADEC (SAM MODULE)

Suitable for MTU engine with ADEC (ECU7) and SAM module; Engine type: Common J1939.

**Table 34 ADEC (X1 Port)**

Terminals of controller	ADEC (X1port)	Remark
Fuel relay output	X1 43	X1 Terminal 28 connected to negative of battery.
Starting relay output	X1 37	X1 Terminal 22 connected to negative of battery.

**Table 35 SAM (X23 Port)**

Terminals of controller	SAM (X23 port)	Remark
CAN(H)	X23 2	Using impedance 120Ω connecting line.
CAN(L)	X23 1	Using impedance 120Ω connecting line.

#### 14.14 PERKINS

Suitable for ADEM3/ADEM4 engine control module; Engine model is 2306, 2506, 1106, and 2806.  
Engine type: Perkins.

**Table 36 Connector**

Terminals of controller	Connector	Remark
Fuel relay output	1, 10, 15, 33, 34	
Starting relay output	-	Connect to starter coil directly.
CAN(H)	31	Using impedance 120Ω connecting line.
CAN(L)	32	Using impedance 120Ω connecting line.



#### 14.15 SCANIA

Suitable for S6 engine control module; Engine model is DC9, DC12, and DC16. Engine type: Scania.

**Table 37 B1 Connector**

Terminals of controller	B1 connector	Remark
Fuel relay output	3	
Starting relay output	-	Connect to starter coil directly.
CAN(H)	9	Using impedance 120Ω connecting line.
CAN(L)	10	Using impedance 120Ω connecting line.

#### 14.16 VOLVO EDC3

Suitable engine control mode is TAD1240, TAD1241, and TAD1242; Engine type: Volvo.

**Table 38 "Stand alone" Connector**

Terminals of controller	"Stand alone" connector	Remark
Fuel relay output	H	
Starting relay output	E	
Programmable output 1	P	ECU power; Set configurable output 1 "ECU power".

**Table 39 "Data Bus" Connector**

Terminals of controller	"Data bus" connector	Remark
CAN(H)	1	Using impedance 120Ω connecting line.
CAN(L)	2	Using impedance 120Ω connecting line.

**NOTE:** When this engine type is selected, preheating time should be set to at least 3 seconds.

#### 14.17 VOLVO EDC4

Suitable engine models are TD520, TAD520 (optional), TD720, TAD720 (optional), TAD721, TAD722, and TAD732. Engine type: Volvo-EDC4.

**Table 40 Connector**

Terminals of controller	Connector	Remark
Fuel relay output	Expansion 30A relay, providing battery voltage for terminal 14; Fuse is 16A.	
Starting relay output	-	Connect to starter coil directly.
	1	Connected to negative of battery.
CAN(H)	12	Using impedance 120Ω connecting line.
CAN(L)	13	Using impedance 120Ω connecting line.

#### 14.18 VOLVO-EMS2

Volvo Engine models are TAD734, TAD940, TAD941, TAD1640, TAD1641, and TAD1642. Engine type: Volvo-EMS2. Speed regulating can be realized.

**Table 41 Engine CAN Port**

Terminals of controller	Engine's CAN port	Remark
Auxiliary output 1	6	ECU stop; Set configurable output 1 to "ECU stop".
Auxiliary output 2	5	ECU power; Set configurable output 2 to "ECU power".
	3	Negative power.
	4	Positive power.
CAN(H)	1(Hi)	Using impedance 120Ω connecting line.
CAN(L)	2(Lo)	Using impedance 120Ω connecting line.

**NOTE:** When this engine type is selected, preheating time should be set to at least 3 seconds.

#### 14.19 YUCHAI

Suitable for BOSCH common rail electronic-controlled engine. Engine type: BOSCH; and speed regulating can be realized.

**Table 42 Engine 42-pin Port**

Terminals of controller	Engine 42 pins port	Remark
Fuel relay output	1.40	Connect to engine ignition lock.
Starting relay output	-	Connect to starter coil directly.
CAN(H)	1.35	Using impedance 120Ω connecting line.
CAN(L)	1.34	Using impedance 120Ω connecting line.

**Table 43 Engine 2-pin Port**

Battery	Engine 2 pins	Remark
Battery negative	1	Wire diameter 2.5mm <sup>2</sup> .
Battery positive	2	Wire diameter 2.5mm <sup>2</sup> .

#### 14.20 WEICHAI

Suitable for Weichai BOSCH common rail electronic-controlled engine. Engine type: GTSC1; and speed regulating can be realized.

**Table 44 Engine Port**

Terminals of controller	Engine port	Remark
Fuel relay output	1.40	Connect to engine ignition switch.
Starting relay output	1.61	
CAN(H)	1.35	Using impedance 120Ω connecting line.
CAN(L)	1.34	Using impedance 120Ω connecting line.

**NOTE:** If there is any question of connection between controller and ECU communication, please feel free to contact SmartGen's service.

## 15 TROUBLE SHOOTING

**Table 45 Troubleshooting**

Symptoms	Possible Solutions
Controller no response with power	Check starting battery; Check controller wirings; Check DC fuse.
Engine stop	Check water/cylinder temperature is too high; Check DC fuse.
Controller emergency stop	Check emergency stop button function is right or not; Check wire connection is open circuit or not.
Oil pressure low alarm after crank disconnection	Check oil pressure and its wire connections.
Water temp. high alarm after crank disconnection	Check water temperature sensor and its wire connections.
Shutdown alarm in running	Check related switch and wirings according to LCD information; Check programmable input ports.
Crank failure	Check fuel circuit and related wirings; Check starting battery; Check speed sensor and its wire connections; Refer to engine manual.
None response for starter	Check starter wire connections; Check starting battery.
RS485 communication is abnormal	Check RS485 wire connections; Check RS485 COM port settings are correct or not; Check RS485 A and B are connected reversely or not; Check RS485 conversion module is damaged or not; Check PC communication port is damaged or not.
ECU communication failure	Check wire CAN high and CAN low polarity; Check 120Ω resistor is connected correctly or not; Check engine type is selected right or not; Check wire connection between controller and engine is right or not; output port settings are right or not.
ECU warning or shutdown	Refer to alarm screen to obtain information; If there is detailed alarm information, then check engine according to it; If there is not, refer to engine manual to obtain information according to SPN alarm code.

**16 PACKING LIST****Table 46 Packing List**

No.	Name	Number	Remark
1	Controller	1	
2	Fixing Clips	2	
3	Certificate	1	
4	User Manual	1	

SmartGen