

SmartGen

MAKING CONTROL SMARTER

HAT160 ATS CONTROLLER USER MANUAL

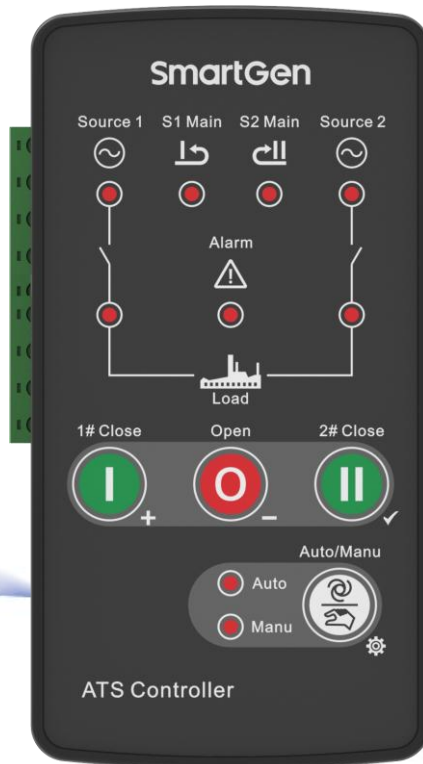

郑州众智科技股份有限公司
SMARTGEN(ZHENGZHOU)TECHNOLOGY CO.,LTD.

SmartGen众智 Chinese trademark

SmartGen English trademark

SmartGen —make your generator *smart*

SmartGen Technology Co., Ltd

No. 28 Jinsuo Road

Zhengzhou City

P. R. China

Tel: +86-371-67988888/67981888/67992951

+86-371-67981000 (overseas)

Fax: +86-371-67992952

Web: www.smartgen.com.cn/

www.smartgen.cn/

Email: sales@smartgen.cn

All rights reserved. No part of this publication may be reproduced in any material form (including photocopying or storing in any medium by electronic means or other) without the written permission of the copyright holder.

Applications for the copyright holder’s written permission to reproduce any part of this publication should be addressed to SmartGen Technology at the address above.



Any reference to trademarked product names used within this publication is owned by their respective companies.

SmartGen Technology reserves the right to change the contents of this document without prior notice.

Table 1 Software Version

Date	Version	Content
2015-12-09	1.0	Original release
2020-03-14	1.1	Fixed description errors
2022-07-27	1.2	Updated company logo and manual format.

Table 2 Sign Instruction

Symbol	Instruction
 NOTE	Highlights an essential element of a procedure to ensure correctness.
 CAUTION	Indicates a procedure or practice, which, if not strictly observed, could result in damage or destruction of equipment.
 WARNING	Indicates a procedure or practice, which could result in injury to personnel or loss of life if not followed correctly.

CONTENTS

1. OVERVIEW.....	4
2. PERFORMANCE AND CHARACTERISTICS.....	5
3. SPECIFICATION	6
4. PANEL DESCRIPTION.....	7
4.1 FRONT PANEL	7
4.2 KEY FUNCTION DESCRIPTION	7
4.3 INDICATOR DESCRIPTION.....	8
4.4 OPERATION.....	8
5. ALARMS	9
5.1 CLOSE/OPEN FAULT ALARM	9
5.2 AUXILIARY INPUT (FIRE RESET INPUT) ALARM	9
5.3 ALARM RESET	9
6. CONNECTION.....	10
7. DEFINITION AND RANGE OF PARAMETERS.....	13
8. PARAMETERS SETTING.....	16
8.1 PARAMETERS SETTING MODE	16
8.2 PARAMETERS SETTING.....	16
8.3 RESET TO DEFAULT	17
9. TYPICAL APPLICATION	18
10. OVERALL DIMENSION AND PANEL CUTOUT	19
10.1 CASE DIMENSION	19
10.2 CUTOUT DIMENSION	19
10.3 INSTALLATION	20
11. TROUBLESHOOTING.....	21

1. OVERVIEW

HAT160 ATS Controller is suitable for CB ATS of single motor with different capacities. It can accurately detect 2-way voltages of 3-phase 4-wire/single-phase 2-wire and make accurate judgment for occurred voltage abnormal situations (such as over voltage, under voltage, over frequency, under frequency and loss of phase), then control ATS transfer after delay. When ATS switch gets abnormal, controller can detect close/open failure and indicates alarm on the front panel to ensure the correct action of ATS. If one power gets abnormal, controller can send signal to start genset. Controller can realize remote communication, remote control and parameter configuration functions via LINK port communication.

SmartGen

2. PERFORMANCE AND CHARACTERISTICS

HAT160 controller can detect 2-way (2-way mains and 2-way gens or 1-way mains and 1-way gens) 3-phase/single phase voltages and control ATS.

Main characteristics are as below:

- Measure and display 2-way 3 phase/single phase voltage and frequency:

1#	2#
Line voltage (Uab, Ubc, Uca)	Line voltage (Uab, Ubc, Uca)
Phase voltage (Ua, Ub, Uc)	Phase voltage (Ua, Ub, Uc)
Frequency Hz	Frequency Hz
- Over/under voltage, over/under frequency and loss of phase detection function, active or not can be configured;
- Close/Open failure alarm indication;
- Panel LEDs can clearly display switch working status;
- Auto/Manual mode transfer. In manual mode, ATS can be switched manually by pressing front panel button;
- 2-way isolated N wire design.
- ATS supply priority (1# Priority/2# Priority (Auto throw auto restore), No priority (auto throw non restore), and 1#/2# power voltage normal/abnormal delay parameters can be set from front panel;
- Re-closing function for power off;
- Over close delay function and delay time is 0.5s;
- If A phase voltage of any one way is normal, controller can control ATS to act. Under the circumstance of A phase voltage of any one way is normal, if 2-way power voltages are abnormal at the same time, ATS will automatically transfer to breaking (neutral) position;
- Forced open input port (fire reset) is fitted; when input is active, ATS will automatically transfer to breaking (neutral) position;
- Parameter setting function: part of parameters can be adjusted from controller front panel, all parameters can be adjusted via LINK port (use SG72A adaptor) on computer software;
- Digital adjustment is applied for parameters, getting rid of analogue modulation method of potentiometer, improving whole reliability and stability;
- Extremely strong anti-electromagnetic interference ability, suitable for usage under complex environment of strong electromagnetic interference;
- Modular structure design, flame retardant ABS shell, pluggable wiring terminal, and compact structure;
- 3 installation methods are offered: panel built-in, internal 35mm guide rail and internal screw mounting.

3. SPECIFICATION

Table 3 Technical Parameters

Items	Contents
Operating Voltage	AC power A1N1/A2N2 supply. Rated AC240V (range: AC170V~277V)
Power Consumption	Under rated voltage, power consumption of voltage circuit is not more than 3VA.
AC Voltage Input: 3-phase 4-wire Single phase 2-wire	AC170V – AC277V (ph-N) AC170V – AC277V (ph-N)
AC Frequency	50/60Hz
Start Relay	7A AC250V Volts free output (Normally close)
1# Close Relay	7A AC250V Volts free output (Normally open)
2# Close Relay	7A AC250V Volts free output (Normally open)
LO/NO Relay Output	7A AC250V
Communication	LINK interface, MODBUS-RTU Protocol
Case Dimensions	86.9mmx158mmx119.5mm
Panel Cutout	73.5mmx144mm
Working Temperature	(-25~+70)°C
Working Humidity	(20~93)%RH
Storage Temperature	(-25~+70)°C
Protection Level	IP55: when waterproof gasket installed between controller and control panel.
Insulation Strength	Apply AC1.5kV voltage between high voltage terminal and low voltage terminal and the leakage current is not more than 3mA within 1min.
Weight	0.6kg

4. PANEL DESCRIPTION

4.1 FRONT PANEL

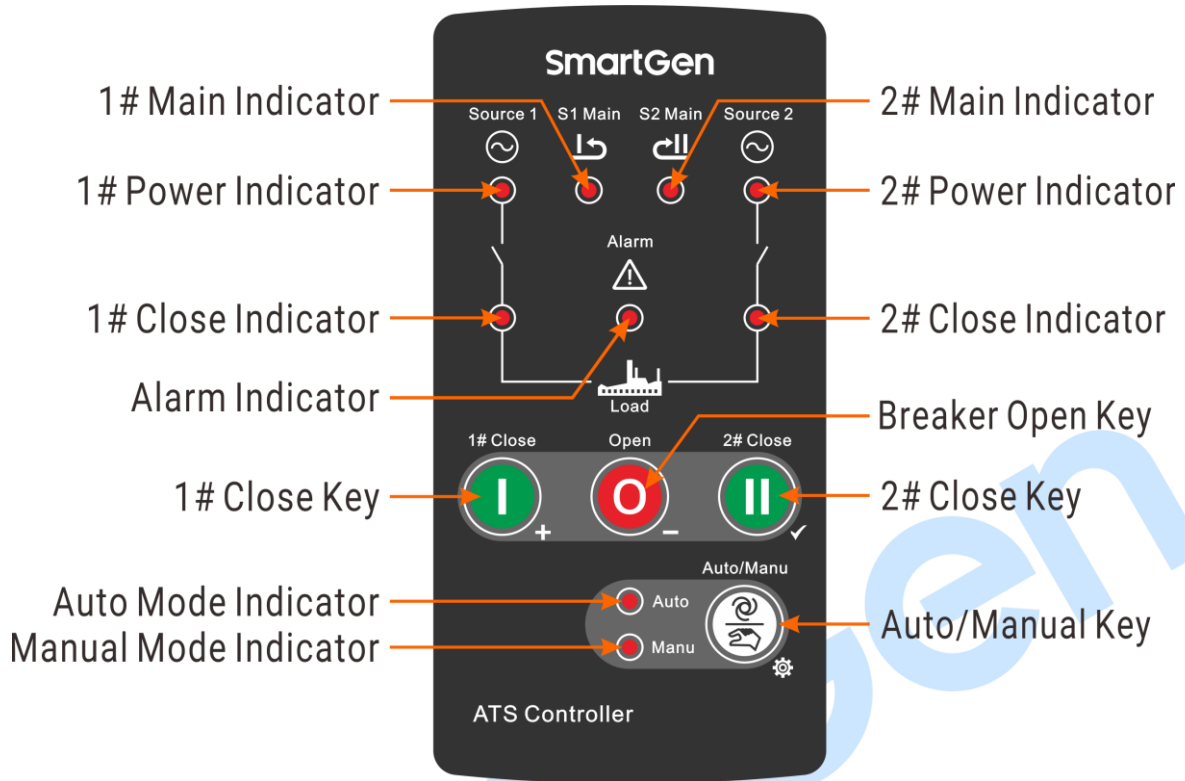

Fig.1 Controller Front Panel

4.2 KEY FUNCTION DESCRIPTION

Table 4 Key Description

Icon	Function	Description
	Auto/Manual (Setting)	Auto/Manual mode switch; Enter into lamp test status by pressing for 3s; Enter into parameter configuration mode by pressing for 5s.
	1# Close	1# Close in Manual mode; Adjust parameters in parameter configuration mode.
	Open	Open in Manual mode; Adjust parameters in parameter configuration mode; Clear alarm status (close/open failure, auxiliary input alarm) if alarms occur in Manual or Auto mode.
	2# Close (Confirm)	2# Close in Manual mode; Confirm parameter value in parameter configuration mode.





4.3 INDICATOR DESCRIPTION

Table 5 Indicator Description

Indicators	Description	
1# Power Indicator ●	Lamp illuminates: 1# power normal; Lamp flashes: 1# power abnormal (over/under voltage, over/under frequency and loss of phase); Lamp off: 1# loss of power.	
2# Power Indicator ●	Lamp illuminates: 2# power normal; Lamp flashes: 2# power abnormal (over/under voltage, over/under frequency and loss of phase); Lamp off: 2# loss of power.	
1# Main Indicator ●	Lamp illuminates: 1# Priority.	Both illuminates: "mutual backup (auto transfer, non-restore)".
2# Main Indicator ●	Lamp illuminates: 2# Priority.	
1# Close Indicator ●	Lamp illuminates: 1# Supply.	
2# Close Indicator ●	Lamp illuminates: 2# Supply.	
Alarm Indicator ●	Lamp illuminates: 1# or 2# Close/Open fault; Lamp flashes: Auxiliary input alarm (Fire Reset input is active).	
Auto Mode Indicator ●	Lamp illuminates: controller in Auto mode.	
Manual Mode Indicator ●	Lamp illuminates: controller in Manual mode; Lamp flashes: enter into parameter configuration mode.	
▲NOTE: Lamp flash frequency: 1Hz.		

4.4 OPERATION

When the controller is normally working in manual mode, press  and it can make controller switch to auto mode, and at this time auto indicator will illuminate.

If controller is in auto mode, press  and it can make controller transfer to manual mode. In manual mode, press  and it can make load transfer to 1# power side; press , and it can make load transfer to 2# power side; press , ATS will transfer to breaking (neutral) position.

▲NOTE: Power On Mode is decided by the last power down mode of the controller. If the controller is in manual mode at power down, it will still in manual mode when power is on again.

5. ALARMS

5.1 CLOSE/OPEN FAULT ALARM

In Auto mode, after the controller sends an open signal, if the controller can also detect close signal when pre-set open delay ends, it will be regarded as open failure and the alarm indicator illuminates at the same time.

In Auto mode, after the controller sends a close signal, if the controller cannot detect close signal when pre-set close delay ends, it will be regarded as close failure and the alarm indicator illuminates at the same time.

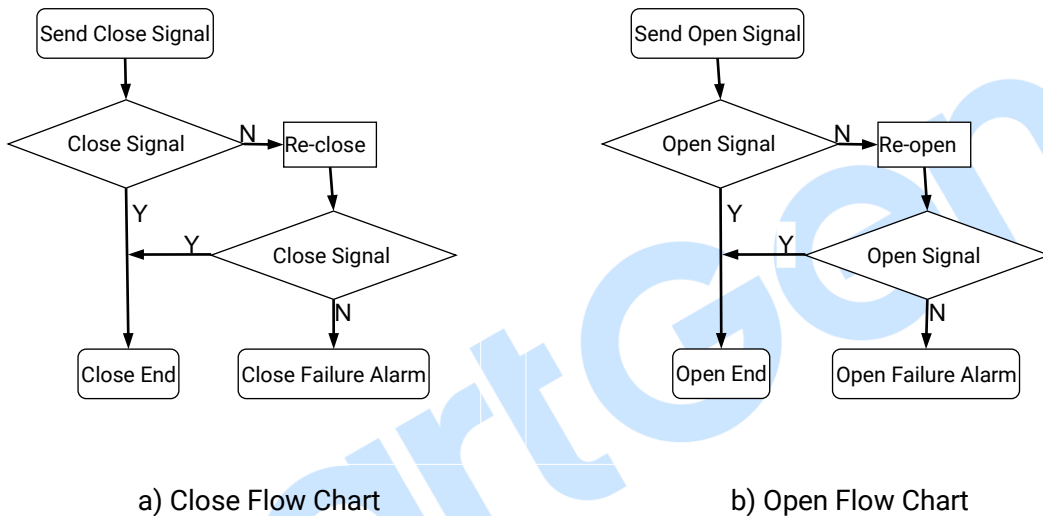





Fig.2 Close/Open Procedure Diagram

5.2 AUXILIARY INPUT (FIRE RESET INPUT) ALARM

When auxiliary alarm input signal or fire reset input signal is detected, the front panel alarm indicator will flash (1Hz), meanwhile the ATS transfers to breaking (neutral) position and alarm will be locked.

5.3 ALARM RESET

If Close/Open alarms in auto mode occur, press  to clear alarm (the indicator will be extinguished at the same time, the controller will Close/Open again after 3s delay), or switch to manual mode to clear alarm by pressing .

If auxiliary input alarms occur, when alarm signal gets inactive, press  to clear alarm and the indicator will be extinguished at the same time.

▲NOTE: At alarm reset, you must ensure fault is removed, otherwise alarm will occur again.

6. CONNECTION



Fig.3 Controller Side Panel

Table 6 Terminal Wiring Description

Terminal	Function	Note
A1	1# A phase	1# AC 3-phase 4-wire voltage input; If it is single-phase, connect A1 and N1 only, B1 and C1 hang up.
B1	1# B phase	
C1	1# C phase	
N1	1# N phase	
A2	2# A phase	2# AC 3-phase 4-wire voltage input; If it is single-phase, connect A2 and N2 only, B2 and C2 hang up.
B2	2# B phase	
C2	2# C phase	
N2	2# N phase	
Q1C	1# Close Relay	Volts free output (Normally open).
M1		
Q2C	2# Close Relay	Volts free output (Normally open).
M2		
M0		M0 short connected with NO internally.
Q10	1# Close Input	Connect to auxiliary normally open contact of 1# power, AC voltage input. When close voltage reaches 70% of rated voltage, close signal is active, when close voltage falls below 65% of rated voltage, close signal is inactive.

Terminal	Function	Note
Q20	2# Close Input	Connect to auxiliary normally open contact of 2# power, AC voltage input. When close voltage reaches 70% of rated voltage, close signal is active, when close voltage falls below 65% of rated voltage, close signal is inactive.
LO NO	ATS Supply Output	Output voltage after transfer of 2-way power A Phase and N Phase; Auto control transfer inside controller;
AL	Auxiliary Alarm Input (Fire Reset Input)	If ATS has trip function, the trip input must be connected to aux. alarm terminal. Can control ATS to switch to Breaking (OFF) position, AC voltage input. When input voltage reaches 70% of rated voltage, aux. alarm signal is active, when input voltage falls below 65% of rated voltage, aux. alarm is inactive.
Gen Start	Start Signal Output	Volts free output (Normally close).
F1 and F2	Fuse Tube	AC 250V/10A.

NOTE: See Typical Application for more details.

LO、NO Switch Diagram

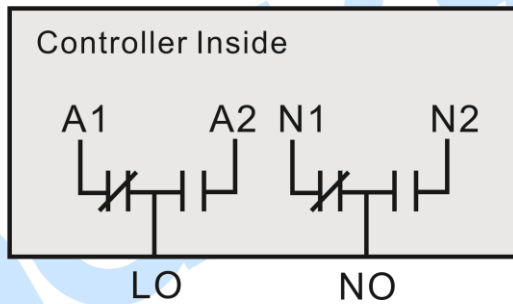

Fig.4 LO and NO Transfer Diagram



Fig.5 Terminals Changing

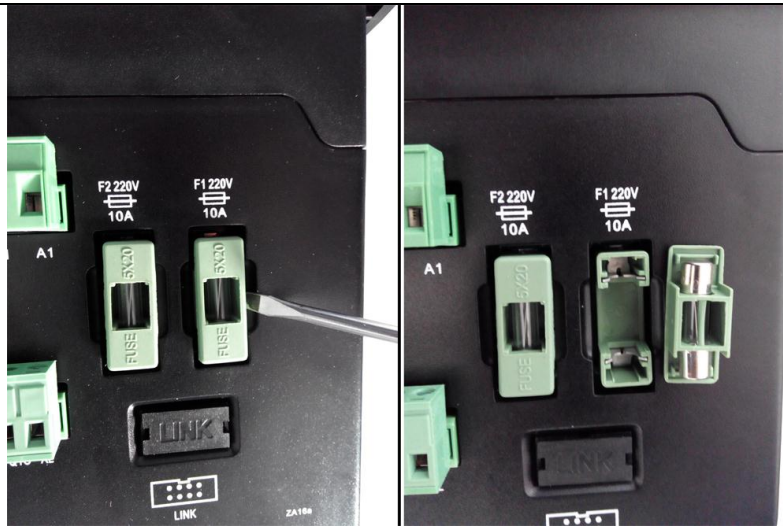

Fig.6 Fuse Changing



Fig.7 Programming via LINK

7. DEFINITION AND RANGE OF PARAMETERS

Table 7 Parameter Setting Contents and Range (1)

No.	Items	Range	Default	Description
1	Priority	(1-3)	1	1: 1# priority 2: 2# priority 3: Mutual backup.
2	1# Volt Abnormal Delay	(1-7)	2 (5s)	1: 1s 2: 5s 3: 10s 4: 20s 5: 30s 6: 45s 7: User defined (Default: 5s)
3	2# Volt Abnormal Delay	(1-7)	2 (5s)	1: 1s 2: 5s 3: 10s 4: 20s 5: 30s 6: 45s 7: User defined (Default: 5s)
4	Start Delay	(1-7)	4 (30s)	1: 3s 2: 8s 3: 15s 4: 30s 5: 50s 6: 70s 7: User defined (Default: 1s)
5	Stop Delay	(1-7)	6 (70s)	1: 3s 2: 8s 3: 15s 4: 30s 5: 50s 6: 70s 7: User defined (Default: 90s)
6	Open Delay	(1-7)	3 (5s)	1: 1s 2: 3s 3: 5s 4: 8s 5: 10s 6: 15s 7: User defined (Default: 5s)

No.	Items	Range	Default	Description
7	Close Delay	(1-7)	3 (5s)	1: 1s 2: 3s 3: 5s 4: 8s 5: 10s 6: 15s 7: User defined (Default: 5s)
8	Switch Transfer Rest	(1-7)	1 (1s)	1: 1s 2: 3s 3: 5s 4: 8s 5: 10s 6: 15s 7: User defined (Default: 1s)
9	1# Volt Normal Delay	(1-7)	2 (5s)	1: 1s 2: 5s 3: 10s 4: 20s 5: 30s 6: 45s 7: User defined (Default: 5s)
10	2# Volt Normal Delay	(1-7)	2 (5s)	1: 1s 2: 5s 3: 10s 4: 20s 5: 30s 6: 45s 7: User defined (Default: 5s)

▲NOTE:

- a) Parameter values in this table can be set from control front panel or computer software;
- b) When delay value is set to "7: User defined", you must set delay value via computer software. If computer software is never used to set parameters, then delay value is Default; If software is used previously, then delay is the pre-set value.



Table 8 Parameter Setting Contents and Range (2)

No.	Item	Range	Default	Description
1	Power Supply	(0-1)	0	0: 3Phase 4Wire 1: 1Phase 2Wire
2	Rated Volt	(170-270)V	230	Provide standard for over/under volt judgment. Provide standard for close volt and aux. alarm volt.
3	Rated Freq.	(50.0-60.0)Hz	50.0	Provide standard for over/under frequency judgment.
4	Over Volt Monitor Enabled	(0-1)	1	0: Disabled 1: Enabled
5	Over Volt Threshold	(100-120)%	115	Threshold
6	Over Volt Return	(100-120)%	113	Return
7	Under Volt Monitor Enabled	(0-1)	1	0: Disabled 1: Enabled
8	Under Volt Threshold	(70-100)%	75	Threshold
9	Under Volt Return	(70-100)%	77	Return
10	Over Freq Monitor Enabled	(0-1)	1	0: Disabled 1: Enabled
11	Over Freq Threshold	(100-120)%	110	Threshold
12	Over Freq Return	(100-120)%	104	Return
13	Under Freq Monitor Enabled	(0-1)	1	0: Disabled 1: Enabled
14	Under Freq Threshold	(80-100)%	90	Threshold
15	Under Freq Return	(80-100)%	96	Return
16	Loss of Phase Monitor Enabled	(0-1)	1	0: Disabled 1: Enabled (Settled delay: 3s)

NOTE: The parameters in this table can only be set via computers.

8. PARAMETERS SETTING

8.1 PARAMETERS SETTING MODE

In manual mode, pressing  for 5s and enter into parameters setting mode and manual indicator  flashes; ①, ②, ③, ④ indicators illuminate as Fig. 5.

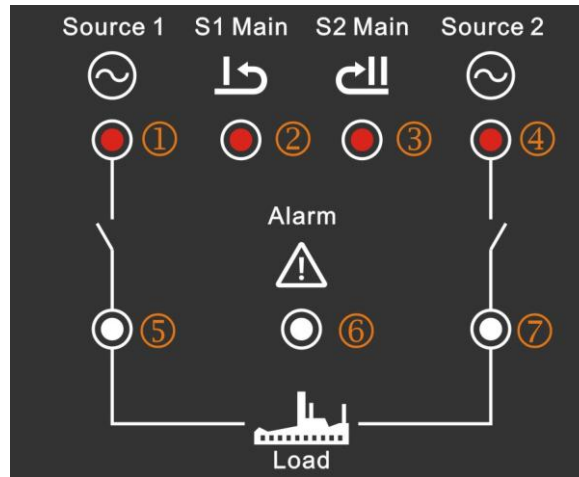









Fig.8 Parameter Configuration LED Display

8.2 PARAMETERS SETTING

When it enters into parameter setting mode, press  and enter into parameter modifying mode. At this time ①, ②, ③, ④ indicators indicate setting item numbers; ⑤, ⑥, ⑦ indicators mean the item parameter values.

Specific settings are as below:

- 1) Select setting number which needs to adjust by pressing  and ;
- 2) Enter into setting status by pressing  and illuminated indicators of ⑤, ⑥, ⑦ flashes;
- 3) After setting this parameter by pressing  and , save the values by pressing .

▲NOTE 1: Please refer to Chapter 7 for parameter list, Table 7 Parameter Setting Contents and Range (1), the No. in the table is the setting item number;

▲NOTE 2: In setting process, discontinue present setting by pressing  at any time, exit with the present value not saved.

▲NOTE 3: Please refer to Table 9 Parameter Value Comparison for LED indicator corresponded values.

8.3 RESET TO DEFAULT

In parameter setting mode, press **I**, and ① ③ ④ indicators illuminate and ⑦ indicator flashes; press **II**, ⑦ indicator illuminates, which means it can reset to default; exit this mode by pressing **Ⓜ** at any time in this process.

Table 9 Parameter Value Comparison

No. LED Indicators				Value	No. LED Indicators			Value
①	②	③	④		⑤	⑥	⑦	
○	○	○	●	1	○	○	●	1
○	○	●	○	2	○	●	○	2
○	○	●	●	3	○	●	●	3
○	●	○	○	4	●	○	○	4
○	●	○	●	5	●	○	●	5
○	●	●	○	6	●	●	○	6
○	●	●	●	7	●	●	●	7
●	○	○	○	8				
●	○	○	●	9				
●	○	●	○	10				

9. TYPICAL APPLICATION

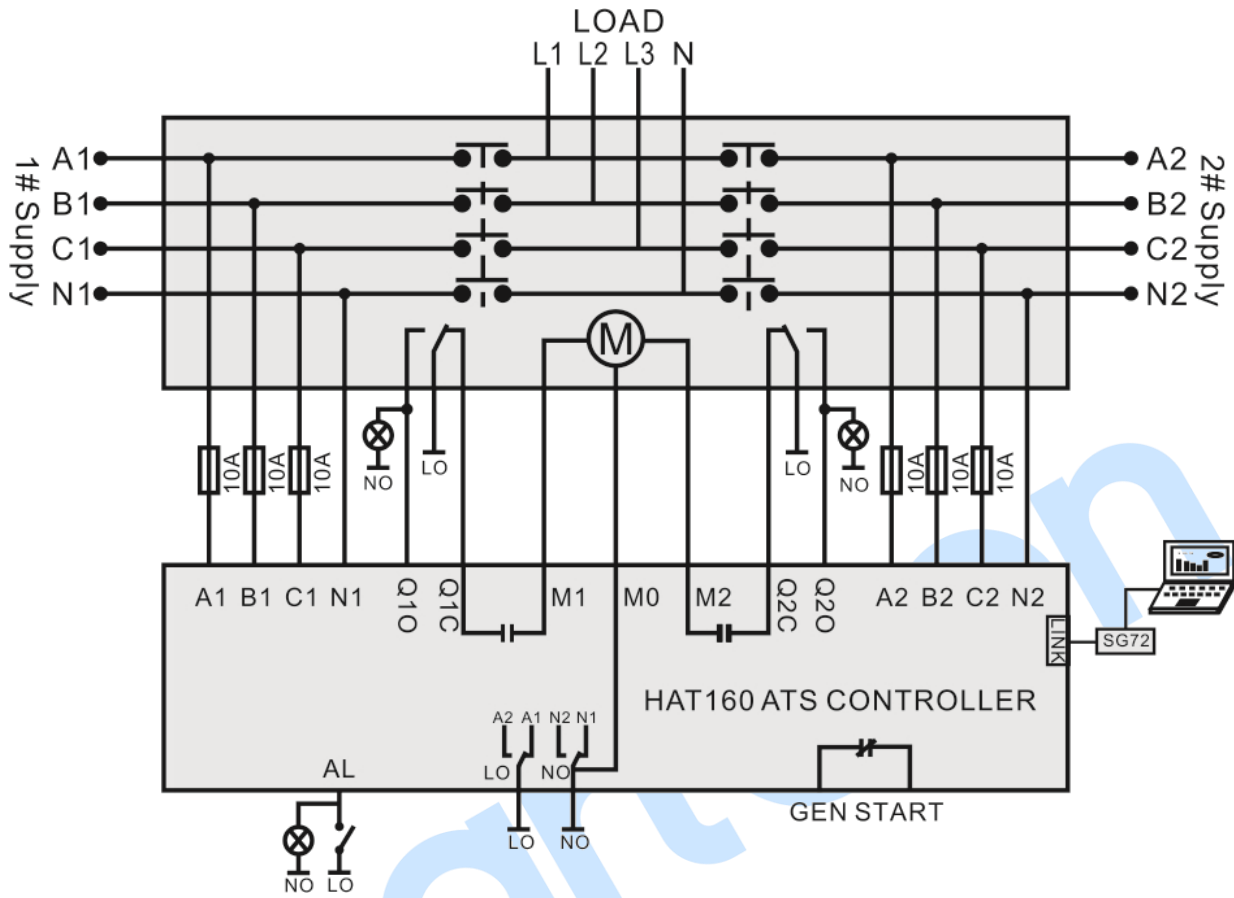

Fig.9 Typical Application Diagram

⚠ CAUTION:

- 1) If ATS has trip function, then it must be connected to AL port (AC Volt input).
- 2) Ensure 1# and 2# A phase won't be abnormal at the same time, otherwise the controller won't send Close/Open signal.

10. OVERALL DIMENSION AND PANEL CUTOUT

10.1 CASE DIMENSION

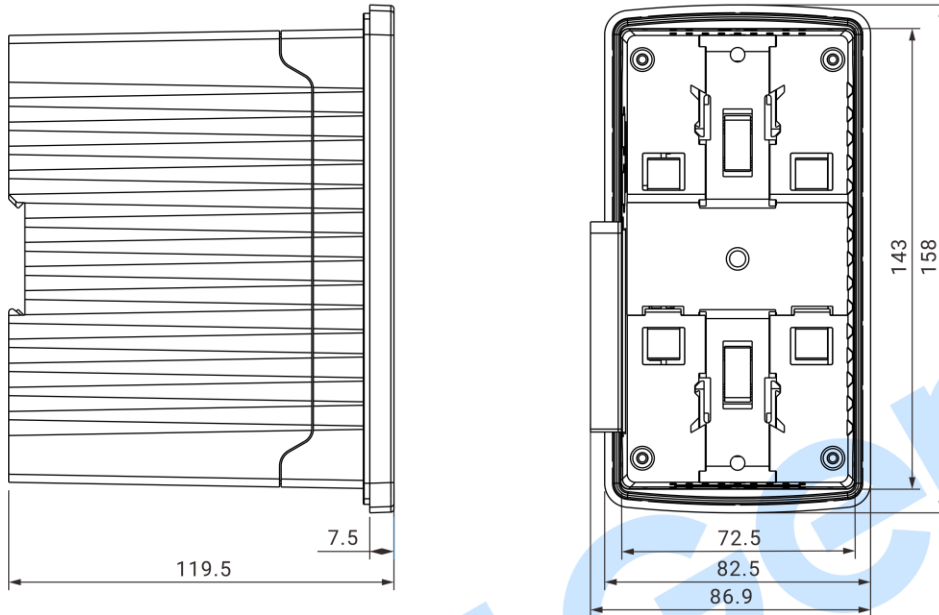

Fig.10 Case Dimension (Unit: mm)

10.2 CUTOUT DIMENSION

The controller has three installation ways: panel built-in, internal 35mm guide rail and internal screw mounting. Panel built-in and internal screw mounting sizes are as below:

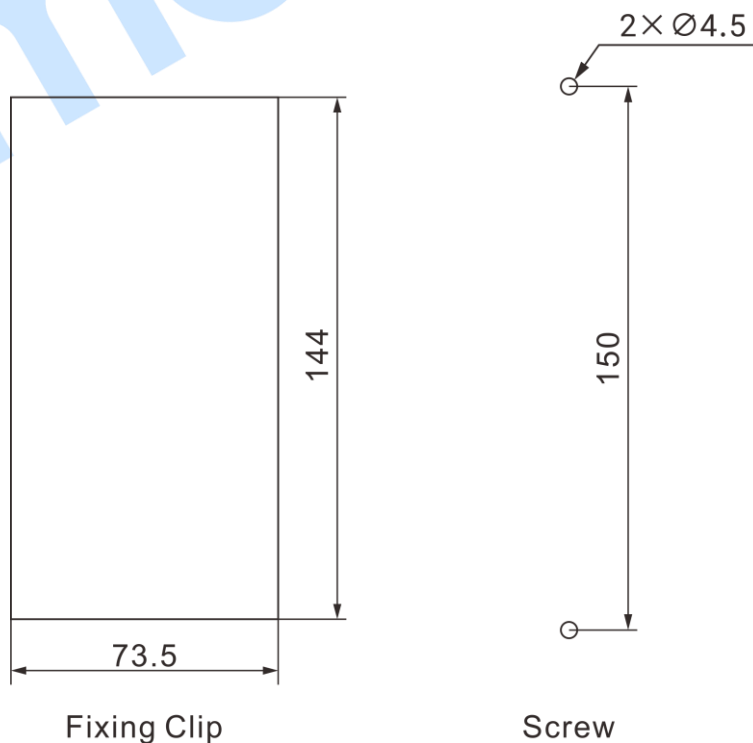

Fig.11 Installation Cutout Dimension (Unit: mm)

10.3 INSTALLATION



a) Fixing Clips



b) 35mm Guide Rail



c) Screw Mounting

11. TROUBLESHOOTING

Table 10 Troubleshooting

Symptom	Possible Remedy
Controller inoperative	Check connections and voltages of 1# and 2# power; Check F1 or F2 fuse tubes.
Switch not activate but controller displays normal	Check ATS structure; Check the connections between controller and ATS.
1# or 2# power indicator flashes	Check whether AC voltage is normal or not.
Alarm indicator flashes	Remove trip status of the switch and reset alarm.
Alarm indicator illuminates	Check the connections between controller and ATS. Check if auxiliary contact is reliably connected; Check Close/Open delay value, appropriately increase the value.
Genset failed to stop when switch has transferred	Disconnect controller power; check if auxiliary contact is reliably connected.

